



Explorer 710 VHF





VHF Marine Radio

Operation and Installation Manual

NORTHSTAR

www.northstarnav.com

IMPORTANT SAFETY INFORMATION
Please read carefully before installation and use.

	This is the safety alert symbol. It is used to alert you to potential personal injury hazards, Obey all safety messages that follow this symbol to avoid possible injury or death.
	WARNING indicates a potentially hazardous situation which, if not avoided, could result in death or serious injury
	CAUTION indicates a potentially hazardous situation which, if not avoided, could result in minor or moderate injury.
	CAUTION used without the safety alert symbol indicates a potentially hazardous situation which, if not avoided, may result in property damage.

DISCLAIMER: It is the owner's sole responsibility to install and use the instrument and transducers in a manner that will not cause accidents, personal injury or property damage. The user of this product is solely responsible for observing safe boating practices.

BRUNSWICK NEW TECHNOLOGIES INC. AND ITS SUBSIDIARIES AND AFFILIATES DISCLAIM ALL LIABILITY FOR ANY USE OF THIS PRODUCT IN A WAY THAT MAY CAUSE ACCIDENTS, DAMAGE OR THAT MAY VIOLATE THE LAW.

Governing Language: This statement, any instruction manuals, user guides and other information relating to the product (Documentation) may be translated to, or

has been translated from, another language (Translation). In the event of any conflict between any Translation of the Documentation, the English language version of the Documentation will be the official version of the Documentation.

This manual represents the Explorer 710 as at the time of printing. Brunswick New Technologies Inc. and its subsidiaries and affiliates reserve the right to make changes to specifications without notice.

Copyright © 2006 Brunswick New Technologies Inc. Northstar™ is a registered trademark of Brunswick New Technologies Inc

FCC Statement

Note: This equipment has been tested and found to comply with the limits for a Class B digital device, pursuant to Part 15 of the FCC Rules. These limits are designed to provide reasonable protection against harmful interference in a normal installation. This equipment generates, uses and can radiate radio frequency energy and, if not installed and used in accordance with the instructions, may cause harmful interference to radio communications. However, there is no guarantee that interference will not occur in a particular installation. If this equipment does cause harmful interference to radio or television reception, which can be determined by turning the equipment off and on, the user is encouraged to try to correct the interference by one or more of the following measures:

- Reorient or relocate the receiving antenna.
- Increase the separation between the equipment and receiver.
- Connect the equipment into an output on a circuit different from that to which the receiver is connected.
- Consult the dealer or an experienced technician for help.
- A shielded cable must be used when connecting a peripheral to the serial ports.

Contents

Section 1 - General Information	5
1-1 Features	5
1-2 Customizing your Northstar VHF Radio	5
1-3 How to Display and Navigate Menus.....	6
1-4 How to Enter Alphanumeric Data	6
1-5 LCD Symbols and Meanings	6
1-6 Basic Operation and Key Functions	8
Section 2 - The Radio Menu (MENU)	11
2-1 Radio Menu Options (Menu)	11
2-2 Maintain Your Buddy List (BUDDY LIST)	12
2-3 Local or Distance Sensitivity (LOCAL/DIST)	13
2-4 Backlighting (BACKLIGHT) and Contrast (CONTRAST).....	13
2-5 GPS Data and Time (GPS/DATA).....	14
2-6 GPS Simulator (SIMULATOR).....	17
2-7 Reset to Factory Defaults (RESET)	17
Section 3 - Radio Setup Menu (RADIO SETUP)	18
3-1 Radio Setup Menu (RADIO SETUP).....	18
3-2 Channel Names (CH NAME)	18
3-3 RING & BEEP Volume (RING VOL) and (BEEP VOL)	19
3-4 Internal Speaker Connections (INT SPEAKER)	19
3-5 Set the Priority Channel (WATCH MODE).....	19
3-6 Weather Alert (Wx ALERT)	20
3-7 NMEA protocol (COM PORT).....	20
Section 4 - DSC Setup Menu (DSC SETUP)	21
4-1 DSC Setup - Menu Options	21
4-2 Enter Your USER MMSID (USER MMSID)	21
4-3 Maintain Your Groups (GROUP SETUP).....	22
4-4 Response to Individual Calls (INDIV REPLY)	23
4-5 ATIS MMSID & ATIS Functionality	23
4-6 DSC functionality options (DSC FUNC).....	24
4-7 Response Type to LL Polling Calls (LL REPLY)	25
Section 5 - Sending and Receiving DSC Calls.....	26
5-1 WHAT IS DSC?	26
5-2 Sending DSC calls	26
5-3 Receiving DSC Calls	30

Section 6 - Distress Calls	32
6-1 Sending a Distress Call	32
6-2 Receiving a Distress Call (DISTRESS!)	33
6-3 Distress Acknowledgement (distress ack) or Relay	33
Appendix A - Technical Specifications	34
Appendix B - Troubleshooting	36
Appendix C - VHF Marine Channel Charts	37
Appendix D - MMSID and License Information	49
Section 7 - Installation Section	50

RF Emissions Notice:

This equipment complies with FCC radiation exposure limits set forth for an uncontrolled environment. This device's antenna must be installed in accordance with provided instructions; and it must be operated with minimum 96 cm spacing between the antennas and all person's body (excluding extremities of hands, wrist and feet) during operation. Further, this transmitter must not be co-located or operated in conjunction with any other antenna or transmitter.

IMPORTANT:

1. Some features described in this manual are not available on every model. In particular, DSC functions are NOT available.
2. DSC functions will not operate on the 710US or the 710EU until your MMSID has been entered. Refer to section 4.2 for details.
3. The radio channels installed into the Northstar VHF radio may vary from country to country, depending upon the model, and government or national communications authority regulations.
4. Northstar NZ Ltd recommends that you check the radio operating licensing requirements of your country before using the Northstar VHF radio. The operator is solely responsible for observing proper radio installation and usage practices.
5. A DSC warning label is supplied with the 710US. To comply with FCC regulations, this label must be affixed in a location that is clearly visible from the operating controls of this radio. Make sure that the chosen location is clean and dry before applying this label.

Section 1 - General Information

1-1 Features

Congratulations on your purchase of a Northstar VHF 710US, or 710EU marine band VHF radio. All of these models provide the following useful features:

- Prominent channel display
- Adjustable contrast settings for the LCD
- Adjustable keypad backlighting for easy night-time use
- Waterproof and submersible to comply with JIS-7
- GPS latitude and longitude (LL) and time display (when connected to a GPS)
- Choice of High or Low (25 W or 1 W) transmission power
- Top centred PTT button for comfortable left- or right-handed use
- Powerful 4 W external audio output
- Access to all currently-available marine VHF channel banks (USA, Canada, International) including weather channels where available
- Special CH16 or CH16/9 key for quick access to the priority (international distress) channel
- Special 3CH key to select your three favourite channels
- PSCAN (similar to dual watch) facility

In addition, the VHF 710 US/EU models also provide:

- DSC (Digital Select Calling) capability that meets USCG SC101 and Class D Standards. 710US only.
- DSC (Digital Select Calling) capability that meets EC Class D Standards. VHF 710EU only.
- DISTRESS call button to automatically transmit the MMSID and position until an acknowledgement is received
- Easy access to a buddy list of up to 20 favourite people
- MMSID storage for three favourite groups
- Group Call and All Ships Call facility
- LL position polling information
- Weather alert facility. VHF 710US only.
- ATIS facility for inland waterways. VHF 710EU only.

1-2 Customizing your Northstar VHF Radio

You can customize the radio to suit your individual preferences. Some preferences can be set directly through the keys as explained in this Section.

Other preferences are set up through the built-in menus and these are explained in the other Sections.

Note: VHF 710CAN operation is the same as VHF 710US. technical and DSC specifications for VHF 710CAN are the same as VHF 710EU

1-3 How to Display and Navigate Menus

1. Hold down MENU (or CALL/MENU). Note that only four menu items can be displayed at any one time on the screen.
2. Press + CH - to scroll up and down the menu until the cursor is positioned at the desired option. Press ENT to display that option.
3. Make any entries or changes as explained in the following section.
4. Press ENT to confirm changes. Otherwise, press ESC to keep the original entry.
5. Press ESC to backup one screen or exit. Any changes are active as soon as you exit the screen.

1-4 How to Enter Alphanumeric Data

If your radio does not have the optional alphanumeric microphone, use the + CH - key to enter alphanumeric data.

Press - to count through numbers, or hold down to scroll rapidly to the desired number.



Press + to step through the alphabet, or hold down to scroll rapidly to the desired character.

If you make an error, press - until < is displayed, then press ENT to backup and correct the entry.

1-5 LCD Symbols and Meanings

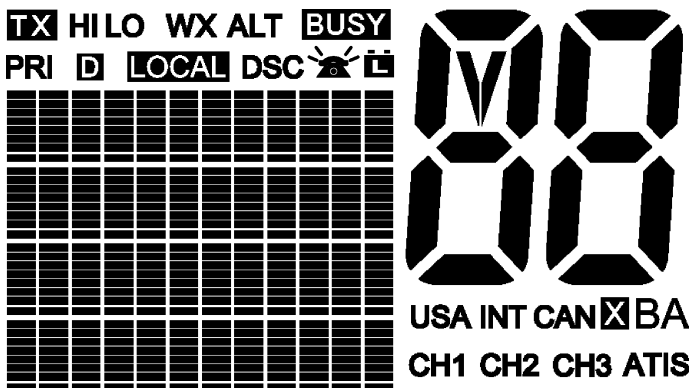
This simulation shows the locations of all the following information symbols:



Symbol	Meaning
TX	Transmitting.
HI LO	Transmission power. High (HI) 25 W or Low (LO) 1 W.
WX	Weather channel.
WX ALT	Weather Alert. Alarm beeps will sound. VHF 710US only.
BUSY	Receiver busy with an incoming signal.
PRI	Priority channel is selected.
D	Duplex operation. Otherwise, blank for Simplex operation.
LOCAL	Local calling is selected. Otherwise, blank for distance calling.
DSC	DSC capability is available. VHF 710US and VHF 710EU only.
	Indicates an incoming DSC call, or blinks to notify you of any unread Call Log messages
	Low Battery warning (activates at 10.5 V)
88	Channel selected.
USA INT CAN	Selected channel bank for VHF radio operations and regulations.
X	Channel is temporarily deleted from the ALL SCAN operation.
B A	Channel suffix, if applicable.
CH1 CH2 CH3	Shows which of the 3 favourite channels, if any, are selected. Otherwise blank.
ATIS	Enabled for use in European inland waterways. Otherwise blank. VHF 710EU only.

A typical operational display is shown here.

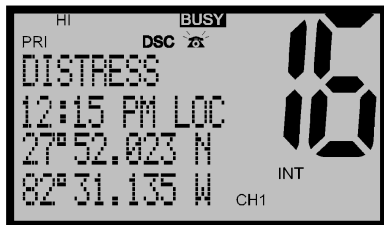

The latitude and longitude of the vessel and the local time are shown.

A transmission on Channel 16 is being made at high power using the International channel bank.

Channel 16 is set as the Priority channel. It is also set as favourite channel 1.

There is an incoming DSC call so the receiver is busy.

1-6 Basic Operation and Key Functions

All possible keys and their functions are listed. Note that some of the keys are not available depending on your Northstar VHF radio model.

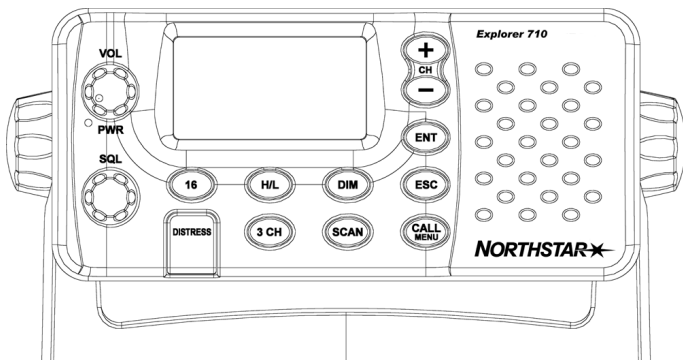

Key	Function
VOL/PWR	Volume and Power. Turn clockwise to power on. Continue to turn until a comfortable volume is reached. VOL/PWR will also adjust the settings of an external speaker, if connected.
SQL	Squelch or Threshold Level. Sets the threshold level for the minimum receiver signal. Turn fully counterclockwise until random noise is heard, then turn slowly clockwise until the random noise disappears. Make another 1/4 turn clockwise for best reception in open sea conditions. In areas of high noise (eg close to large cities) reception may improve if sensitivity is reduced. Either turn SQL slowly clockwise or use the LOCAL setting. See section 2.3.
16/9	Priority Channel. VHF 710US only. Also on the microphone. Press to cancel all other modes and to tune into the priority channel. Press again to return to your original channel. The default is Channel 16. To make Channel 09 the priority channel, hold down 16/9 until a beep sounds and 09 is displayed.
16	Priority Channel. VHF 710EU. Also on the microphone. Press to cancel all other modes and to tune into the priority channel, Channel 16, on high power. Press again to return to your original channel.
WX	Weather Channel. VHF 710US. In USA and Canadian waters, press to hear the most recently selected weather station. The WX symbol is displayed on the LCD. Press + or - to change to a different weather channel. Press WX again to return to the most recent channel. If the weather alert mode (ALT) is ON and an alert tone of 1050Hz is broadcast from the weather station, it is picked up automatically and the alarm sounds. Press any key to hear the weather alert voice message.

H/L	<p>Transmission Power. High (HI) 25 W or Low (LO) 1 W. Press to toggle between high or low transmission power for the entire channel bank. The HI or LO selection is shown on the LCD.</p> <p>Some channels allow only low power transmissions. Error beeps will sound if the power transmission setting is incorrect.</p> <p>Some channels allow only low power transmissions initially, but can be changed to high power by holding down H/L and PTT at the same time. See Appendix C for a complete listing of channel charts.</p>
3CH	<p>Three Favourite Channels. Also on the microphone. Press to toggle between your favourite channels. The CH1, CH2, or CH3 symbol appears on the LCD to show which favourite channel is selected.</p> <p>To scan only one of your favourite channels, press 3CH then immediately press and release SCAN. If you want to scan all three favourite channels, press 3CH then immediately press and hold SCAN.</p> <p>To add a favourite channel for the first time, select that channel then hold 3CH to store it in the CH1 location. Repeat the procedure to store two more favourite channels in the CH2 and CH3 locations respectively.</p> <p>If you try and add another favourite channel it will overwrite the existing CH3. CH1 and CH2 remain unless you delete them.</p> <p>To delete a favourite channel, select that channel then hold down 3CH until the CH1, CH2 or CH3 symbol disappears off the LCD.</p>
UIC	<p>Channel Bank. <i>710US only.</i> Press to toggle between USA, International or Canadian channel banks. The selected channel bank is displayed on the LCD along with the last used channel. All the channel charts are shown in Appendix C.</p>
U/I	<p>Channel Bank. Press to toggle between channel banks. Note that the channel banks available are dependent upon your VHF radio model. The selected channel bank is displayed on the LCD along with the last used channel. All the channel charts are shown in Appendix C.</p>
DIM	<p>Backlighting. <i>710EU only.</i> Press to toggle between the backlighting settings. OFF will extinguish all the backlighting except for the DISTRESS key. (Otherwise, use the menu to change the backlight setting.)</p>
SCAN	<p>Scan. Press to scan between your current channel and the priority channel in DUAL or TRI WATCH mode. The weather channel is also scanned if the USA channel bank is selected and the weather alert mode (ALT) is ON.</p> <p>Hold down SCAN to enter ALL SCAN mode where the priority channel is checked every 1.5 seconds.</p> <p>When a signal is received, scanning stops at that channel and BUSY appears on the screen. If the signal ceases for more than 5 seconds, the scan restarts.</p> <p>Press ENT to temporarily skip over (lock out) an "always busy" channel when in ALL SCAN mode and resume the scan. An X is shown on the screen to designate a skipped channel. Note that it is not possible to skip over the priority channel.</p> <p>Press SCAN to stop at the current channel.</p>
+ CH -	<p>Channel Select. <i>Also on the microphone.</i> The current channel is shown on the screen in BIG digits with an appropriate designator suffix A or B in small letters below the channel number.</p>

Press + or - to step through the available channels one at a time, or hold down to scroll rapidly through all the available channels. See Appendix C for a listing of channel charts.

Alphanumeric Entry. This key can also be used for menu selection and for alphanumeric entry. Press + or - to scroll the cursor up or down menu options when navigating menus.

When editing an item containing only numbers, press - to count through the numbers or hold down to scroll rapidly.

To enter a character, press + to step through the alphabet or hold down to scroll rapidly.

ENT	Enter. Use ENT when navigating menus, to confirm entries and edits.
ESC	Escape. Use ESC when navigating menus, to clear incorrect entries, to exit from a menu without saving changes, and to back up to the previous screen.
CALL/MENU	DSC Setup Menu and DSC Call Menu. <i>710US and 710EU only.</i> Press to enter the DSC Call Menu and make DSC calls. See Section 5. Hold down to enter MENU SELECT. Scroll to DSC SETUP to setup your MMSID and other DSC information. Go to RADIO SETUP to customize your Northstar VHF radio. See Section 4.
MENU	Radio menu. <i>7000 only.</i> Press to enter the Radio Menu and customize your Northstar VHF radio. See Section 3.
DISTRESS	Send DSC Distress Call. <i>710US & 710EU only.</i> See Section 6.
PTT	Press To Talk. Press PTT to transmit at any time on an allowable channel. This automatically exits you from menu mode and stops scanning. You must release PTT to receive a signal. If PTT sticks, a built-in timer will automatically shut down a transmission after five minutes and sound the error beeps. This time out is required by FCC regulations.

Note: VHF 710CAN operation is the same as VHF 710US. Technical and DSC specifications for VHF 710CAN are the same as VHF 710EU

Section 2 - The Radio Menu (MENU)

2-1 Radio Menu Options (Menu)

The following options are available through MENU (or CALL/MENU):

BUDDY LIST LOCAL/DIST	Maintain your buddy list. <i>See Section 2-2.</i>	Set radio sensitivity. <i>See Section 2-3.</i>
BACKLIGHT CONTRAST	Set backlight level. <i>See Section 2-4.</i>	Set contrast level. <i>See Section 2-4.</i>
GPS/DATA	MANUAL SETTING	Set position & UTC manually. <i>See Section 2-5.</i>
		Set local time and time format. <i>See Section 2-5.</i>
DSC SETUP	USER MMSID GROUP SETUP INDIV REPLY DSC FUNC ATIS MMSID ATIS FUNC LL REPLY	DSC Setup Menu. 710US and 710EU only. <i>See Section 4.</i> Make DSC calls. 710US and 710EU only. <i>See Section 5.</i>
RADIO SETUP	CH NAME RING VOLUME BEEP VOLUME INT SPEAKER WATCH MODE WX ALERT COM PORT	Radio Setup Menu. <i>See Section 3.</i>
GPS SIM RESET		Turn the GPS Simulator on/off. <i>See Section 2.6.</i> Reset factory settings. <i>See Section 2.7.</i>

1-3 and 1-4 explain how to navigate around the menu and enter, save and change data.

2-2 Maintain Your Buddy List (BUDDY LIST)

```
MENU SELECT
>BUDDY LIST
  LOCAL/DIST
  BACKLIGHT
```

VHF 710US and VHF 710EU only.

Use the Buddy List to store the names and associated MMSIDs of 20 favourite people. Names are stored in the order of entry, with the most recent entry shown first.

The following sections show to use BUDDY LIST to add, edit, and delete entries on your buddy list.

Section 3 explains how to call a buddy.

2-2-1 Add an Entry

```
BUDDY LIST
> MANUAL NEW
  ALEX
  TOM
```

```
ENTER NAME
-----
ENTER MMSID
-----
```

```
ENTER NAME
BOB
ENTER MMSID
123456789
```

```
BOB
123456789
> STORE
  CANCEL
```

1. Select BUDDY LIST. The cursor is at MANUAL NEW. Press ENT.
2. Enter the buddy name, one character at a time (this may be alphanumeric) then press ENT repeatedly until the cursor moves to the MMSID entry line.
4. Enter the MMSID associated with that buddy name (this must be numeric) then press ENT.
5. The new buddy name and MMSID are displayed. Press ENT to store the new entry, which is displayed at the top of your buddy list.

Note that when the BUDDY LIST is full (20 entries), you cannot make a new entry until you have deleted an existing entry.

2-2-2 Edit an Entry

```
BUDDY LIST
> MANUAL NEW
  ALEX
  TOM
```

```
ALEX
> EDIT
  DELETE
```

```
EDIT NAME
ALEX
EDIT MMSID
112233445
```

```
ALEX
111223344
> STORE
  CANCEL
```

1. Select BUDDY LIST. Press ENT to display the list of entries.
2. Scroll down (if required) to the incorrect entry and press ENT.
3. Select EDIT. The cursor is at the first character of the name.
4. Edit the buddy name or, to edit only the MMSID, press ENT repeatedly until the cursor moves to the MMSID line.
5. When you are finished, press ENT (repeatedly if necessary) to display the next screen.
6. Press ENT to store the changes. The buddy list is displayed again. If more changes are required, repeat Steps 2 thru 6. Otherwise, press ESC to exit.

2-2-3 Delete an Entry

```
BUDDY LIST
> MANUAL NEW
  ALEX
  TOM
```

```
BUDDY LIST
MANUAL NEW
  ALEX
  > TOM
```

```
TOM
EDIT
> DELETE
```

```
DELETE BUDDY
TOM
> YES
  NO
```

1. Select BUDDY LIST. Press ENT to display the list of entries.
2. Scroll down (if required) to the entry you want to delete and press ENT.
3. Select DELETE then select YES.
4. The entry is deleted immediately and the buddy list is displayed again.

2-3 Local or Distance Sensitivity (LOCAL/DIST)

```
MENU SELECT
BUDDY LIST
> LOCAL/DIST
  BACKLIGHT
```

Use LOCAL/DIST to improve the sensitivity of the receiver either locally (LOCAL) or over distances (DIST).

LOCAL is not recommended for use in open sea conditions. It is designed for use in areas of high radio noise; for example, close to cities.

See also SQL (Squelch Control) in Section 1.6.

2-3-1 Set Distance Sensitivity

```
SENSITIVITY
> DISTANT
  LOCAL
```

1. Select LOCAL/DIST then select DIST.
2. Press ENT to activate the DIST setting. This disables local sensitivity and the menu is displayed again.

2-3-2 Set Local Sensitivity

```
SENSITIVITY
DISTANT
> LOCAL
```

1. Select LOCAL/DIST then scroll to LOCAL.
2. Press ENT to activate the LOCAL setting. This disables distance sensitivity and the menu is displayed again.



LOCAL is displayed on the LCD as a reminder that local sensitivity is selected.

2-4 Backlighting (BACKLIGHT) and Contrast (CONTRAST)

```
MENU SELECT
LOCAL/DIST
> BACKLIGHT
  CONTRAST
```

Use BACKLIGHT to set the backlight levels for the LCD and the keypad at a comfortable level.

The microphone keypad backlighting is either ON or OFF.

Use CONTRAST to set the contrast level for the LCD.

2-4-1 Set the Backlighting Level



1. Select BACKLIGHT.
2. Select a comfortable backlight level using + or - to change the setting.
3. Press ENT to enable the setting and return to the menu.

Note that the DISTRESS key backlighting cannot be switched off.

2.4.2 Set the Contrast Level



1. Select CONTRAST.
2. Select a comfortable contrast level using + or - to change the setting.
3. Press ENT to enable the setting and return to the menu.

2-5 GPS Data and Time (GPS/DATA)

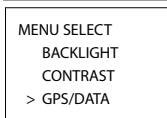

If the boat has an operational GPS navigation receiver, the VHF radio automatically detects and updates the vessel position and the local time.

However, if the GPS navigation receiver is disconnected or absent, you can specify the vessel position and the local time manually, using the GPS/DATA option.

This information is important because it will be used if a DSC distress call is transmitted.

You can also enter the course (COG) and speed (SOG) and select GPS Alert and GPS Simulator options.

2-5-1 Manually Enter Position and UTC Time (MANUAL)

Note that this function is available only if an operational GPS receiver is not connected.

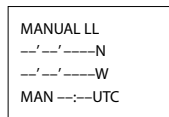
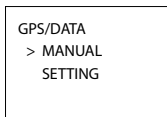

1. Select GPS/DATA, then MANUAL.
2. Enter the latitude, then the longitude, then the UTC.
3. Press ENT when all the information is correct.

The vessel's latitude and longitude are shown on the screen, with the UTC time. The prefix MAN indicates a manual entry. The manual entries are cancelled if a real GPS position is received.

2-5-2 Local Time (TIME OFFSET)

The local time can be set by entering the time offset between UTC and local time as follows.

GPS/DATA
MANUAL
>SETTING

GPS/DATA
> TIME OFFSET
TIME FORMAT
TIME DISPLY

TIME OFFSET
>+01:30

02:30PM LOC

1. Select GPS/DATA, then SETTING.
2. Select TIME OFFSET to enter the difference between UTC and local time. Half hour increments can be used with a maximum offset of ± 13 hours.

In this example, a difference of +1.5 hours has been entered and the local time is displayed with the suffix LOC.

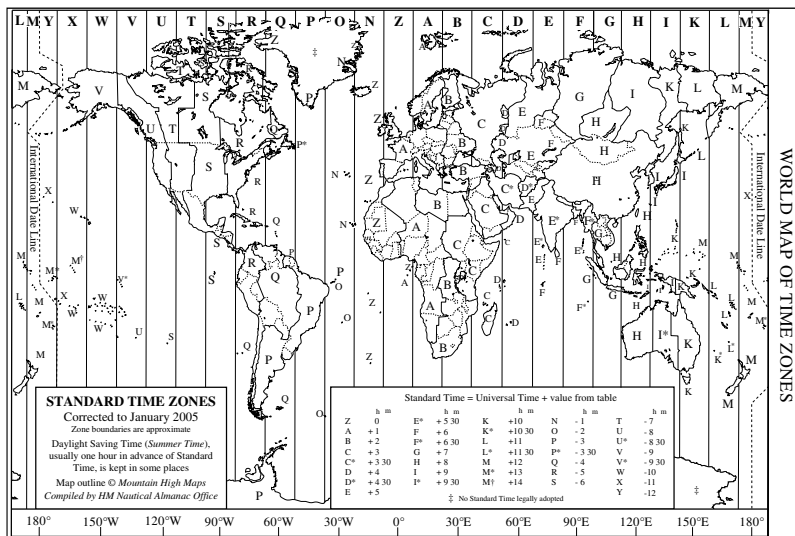

2-5-3 Time Format Options (TIME FORMAT)

Time can be shown in 12 or 24 hour format.

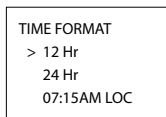
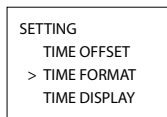
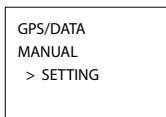

1. Select GPS/DATA, then SETTING.
2. Select TIME FORMAT.
3. Select 12 Hr or 24 Hr as desired. In this example, 12 hour format has been selected and so the LCD shows the AM or PM suffix.

2-5-4 Time Display Options (TIME DISPLAY)

If you have entered the time manually as described in the previous sections, the time is always shown on the screen with the prefix M.

However, if the vessel position is being updated through a GPS navigation receiver, you can switch the time display on the screen ON or OFF as follows:

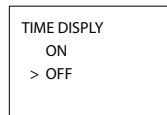
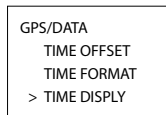

1. Select GPS/DATA, then SETTING.
2. Select TIME DISPLAY.
3. Select ON (on) or OFF (off) as desired. In this example, OFF has been selected and so the screen no longer shows the time.

If the time display is set ON, course and speed data are not displayed on the LCD (see section 2-5-6).

2-5-5 Position Display Options (LL display)

If you have entered the vessel position manually as described in the previous section, the vessel position is always shown on the screen with the suffix M.

However, if the time is being updated through a GPS navigation receiver, you can switch the vessel position display on the screen on or off as follows:

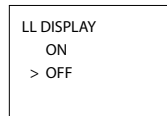
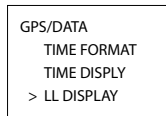

1. Select GPS/DATA, then SETTING.
2. Select LL DISPLAY.
3. Select ON (on) or OFF (off) as desired. In this example, OFF has been selected and the screen no longer shows the vessel position.

2-5-6 Course & Speed Display Options (COG/SOG)

Use this option to display course over ground (COG) and speed over ground (SOG) data on the screen.

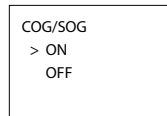
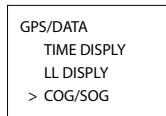

1. Select GPS/DATA, then SETTING.
2. Select COG/SOG.
3. Select ON (on) or OFF (off) as desired. In this example, ON has been selected and so the screen shows the bearing and speed.

If COG/SOG is set ON (on), the time is not displayed on the screen (see section 2-5-4).

2-5-7 GPS Alert Options (ALERT)

The GPS alert is usually set to ON (on) so that if the GPS navigation receiver is disconnected, the alarm sounds.

```
GPS/DATA
LL DISPLY
COG/SOG
> GPS ALERT
```

```
GPS ALERT
> ON
OFF
```

1. Select GPS/DATA, then SETTING.
2. Select GPS ALERT.
3. Select ON (on) or OFF (off) as desired.

2-6 GPS Simulator (SIMULATOR)

The GPS Simulator is set to OFF whenever the radio is turned ON or whenever real GPS data is available through the COM port. However, if you want to test it, turn it on.

```
MENU SELECT
DSC SETUP
RADIO SETUP
> GPS SIM
```

1. Select GPS SIM, then select ON (on) or OFF (off) as desired.

Whenever the GPS Simulator is turned ON (on), simulated Speed Over Ground (SOG), Course Over Ground (COG), and LL position appear on the screen. This data is updated automatically during the simulation.

It is not possible to send a DSC transmission when in Simulator mode.

2-7 Reset to Factory Defaults (RESET)

Use this to return every setting to the factory defaults except all MMSID settings and the entries in your buddy list.

```
MENU SELECT
RADIO SETUP
GPS SIM
> RESET
```

```
RESET RADIO
ARE YOU SURE
> YES
NO
```

1. Select RESET. The radio asks for confirmation.
2. Select YES to reset the radio and return to the menu.

The Call Logs will be cleared but the BUDDY LIST will be saved. The receiver and transmitter factory settings are restored to default conditions.

Section 3 - Radio Setup Menu (RADIO SETUP)

3-1 Radio Setup Menu (RADIO SETUP)

CH NAME	Edit or delete channel names. <i>See Section 3-2.</i>
RING VOLUME	Set the volume level of the incoming call notification beeps. <i>See section 3-3.</i>
BEEP VOLUME	Set the volume level of the beeps. <i>See section 3-3.</i>
INT SPEAKER	Switch ON/OFF (on/off) the radio's internal speakers. <i>See section 3-4.</i>
WATCH MODE	Selects the operation of Dual or Tri watch scanning. <i>See section 3-5.</i>
WX ALERT	(Selects if the WX Alert scanning mode is ON (on) or OFF (off). (VHF 710US only.) <i>See section 3-6.</i>
COM PORT	Select NMEA protocol for communications between the VHF radio and any other instruments. <i>See section 3-7.</i>

Sections 1-3 and 1-4 explain how to navigate around the menu and enter, save and change data.

3-2 Channel Names (CH NAME)

The channel charts are listed in Appendix C with their default name tags. CH NAME gives you the option to edit or delete the channel name tags displayed on the screen.

RADIO SETUP > CH NAME RING VOLUME BEEP VOLUME	CH NAME 01 TELEPHONE	TELEPHONE > EDIT DELETE
EDIT CH NAME TELEPHONE	SAVE CH NAME PHONE1 > YES NO	

1. Select RADIO SETUP, then CH NAME.
2. Use + or - to step through the channels with their name tags until you see the channel name tag you want to change, then press ENT. In this example, the channel name TELEPHONE associated with channel 01 is being changed to PHONE1.
3. Select EDIT and press ENT to edit the existing name tag. Input the new name over the existing name. It can be a maximum of 12 characters.

To delete the channel name, select DELETE and press ENT.

4. Press ENT (repeatedly if necessary) to display the YES/NO confirmation.
5. Press ENT to confirm the new channel name tag or the deletion, then press ESC to return to the menu.

3-3 RING & BEEP Volume (RING VOL) and (BEEP VOL)

Set the volume level of the incoming signal beeps (RING VOLUME) and/or the error and warning beeps (BEEP VOLUME) to HIGH (high) or LOW (low) as follows:

RADIO SETUP
> CH NAME
RING VOLUME
BEEP VOLUME

RING VOLUME
> HIGH
LOW

BEEP VOLUME
> HIGH
LOW
OFF

1. Select RADIO SETUP, then RING VOLUME or BEEP VOLUME as appropriate.
2. Select a HIGH or LOW volume. (It is possible to turn the beeps off completely by selecting BEEP VOLUME then OFF.)
3. Press ENT to enable the new volume setting and return to the menu.

3-4 Internal Speaker Connections (INT SPEAKER)

Switch the radio's internal speaker ON (on) or OFF (off). The external speaker is always ON (on) if a speaker is plugged into the external speaker jack.

RADIO SETUP
RING VOLUME
BEEP VOLUME
> INT SPEAKER

INT SPEAKER
> ON
OFF

1. Select RADIO SETUP, then INT SPEAKER.
2. Select ON (on) or OFF (off) then press ENT to enable the setting and return to the menu.

3-5 Set the Priority Channel (WATCH MODE)

If you have VHF 710EU, watch mode is similar to a dual watch, scanning between the priority channel and the working channel. CH16 is the priority channel.

However, if you have a VHF 710US and are operating on USA or Canadian channel banks, you can set the priority channel to cover both CH16 and CH09 as well as the working channel, as follows:

RADIO SETUP
BEEP VOLUME
INT SPEAKER
> WATCH MODE

WATCH MODE
> ONLY 16CH
16CH+9CH

1. Select RADIO SETUP, then WATCH MODE.
2. Select ONLY 16CH for dual watch mode, or 16CH+9CH for tri watch mode.

3-6 Weather Alert (Wx ALERT)

VHF 710US only.

The NOAA provides several weather forecast channels on USA and Canadian channel banks. If severe weather such as storms or hurricanes are forecast, the NOAA broadcasts a weather alert on 1050 Hz. You can set up the radio to pick up weather alerts, as follows:

```
RADIO SETUP
INT SPEAKER
WATCH MODE
> WX ALERT
```

```
WX ALERT
ON
> OFF
```

1. Select RADIO SETUP, then WX ALERT.
2. Select ON (on) or OFF (off) then press ENT to enable the setting and return to the menu.

When a weather alert is broadcast, the alarm will sound. Press any key to hear the weather alert voice message.

3-7 NMEA protocol (COM PORT)

The radio can be added to a group of instruments using NMEA protocol.

```
RADIO SETUP
WATCH MODE
WX ALERT
> COM PORT
```

```
NMEA
CHECKSUM
> ON
OFF
```

1. Select RADIO SETUP, then COM PORT.
2. Select CHECKSUM ON (on) or OFF (off) then press ENT to enable the setting and return to the menu.

CHECKSUM ON is the usual setting.

Section 4 - DSC Setup Menu (DSC SETUP)

These DSC facilities are available only on the 710US and 710EU and a valid user MMSID must be entered to access the DSC functions.

4-1 DSC Setup - Menu Options

The following options are available:

USER MMSID	Enter your user MMSID. See section 4.2. (If you do not have a user MMSID, see Appendix D.)
GROUP SETUP	Enter or change the name and/or details of a group. <i>See section 4.3.</i>
INDIV REPLY	Choose an automatic or manual response to calls (VHF 710US only). See section 4.4.
ATIS MMSID	Enter or change your ATIS MMSID (VHF 710EU only). <i>See section 4.5.</i>
ATIS FUNC	Enable/disable the ATIS function (VHF 710EU only). <i>See section 4.5.</i>
DSC FUNC	Turn the DSC operation ON/OFF (on/off). <i>See section 4.6.</i>
LL REPLY	Select the type of response to an LL polling request. <i>See section 4.7.</i>

Sections 1.3 and 1.4 explain how to navigate around the menu and enter, save and change data.

4-2 Enter Your USER MMSID (USER MMSID)

This is a **once-only** operation. You must enter your user MMSID before you can access the DSC functions.

DSC SETUP > USER MMSID GROUP SETUP INDIV REPLY	INPUT USER MMSID -----	187654321 MMSID > STORE CANCEL	USER MMSID INPUT AGAIN -----
---	------------------------------	---	------------------------------------

You can display and read your user MMSID at any time, but you get only one opportunity to enter your user MMSID.

1. Select DSC SETUP, then USER MMSID.
2. If this is the first time that you are entering your user MMSID, a dashed line appears.
Enter your user MMSID along the dashed line. Press ENT to confirm each correct entry and to move to the next digit.
If you make an error, press - until < appears, then press ENT to backup and correct the entry.
3. Press ENT to store your user MMSID.
4. Enter your user MMSID again as a password check, then press ENT to permanently store the user MMSID and return to the menu.

You can view your stored user MMSID at anytime by selecting USER MMSID in the main menu.

4-3 Maintain Your Groups (GROUP SETUP)

Use GROUP SETUP to create, edit, or delete 1, 2, or 3 groups of frequently called people stored in alphanumeric order. A group MMSID always starts with 0.

4-3-1 Create a Group (GROUP SETUP)

```
DSC SETUP
USER MMSID
> GROUP SETUP
INDIV REPLY
```

```
GROUP SETUP
> MANUAL NEW
000000000
```

```
GROUP NAME
-----
GROUP MMSID
0-----
```

```
FISHER1
012345678
> STORE
CANCEL
```

1. Select DSC SETUP, then GROUP SETUP.
2. If this is the first time that you are entering a group name, a line of nine zeros appears. Otherwise, any existing group names are displayed. Press ENT to display the input screen.
3. Enter the group name along the dashed line. It can be alphanumeric. Press ENT to confirm each correct entry and to move to the next digit. When you have finished, press ENT repeatedly until the cursor moves to the MMSID line.
If you make an error, press - until < appears, then press ENT to backup and correct the entry.
4. Enter the group MMSID. (Note that the first number is always 0.) Press ENT.
5. The group name and group MMSID are shown in a confirmation screen. Press ENT to store the details and return to the GROUP SETUP screen.

4-3-2 Edit Group Name Details

```
GROUP SETUP
MANUAL NEW
> FISHER1
FRIENDS1
```

```
FISHER1
> EDIT
DELETE
```

```
EDIT NAME
FISHER1
EDIT MMSID
012345678
```

```
FISHER2
012345678
> STORE
CANCEL
```

1. Select DSC SETUP, then GROUP SETUP. The existing group names are displayed. Press + or - to scroll to the incorrect entry then press ENT.
2. Press ENT to edit. The group name details are displayed, with the cursor at the first character of the name.
3. Edit the buddy name or, to edit only the MMSID, press ENT repeatedly until the cursor moves to the MMSID line.
4. When you are finished, press ENT (repeatedly if necessary) to display the next screen.
5. Press ENT to store the changes and return to the GROUP SETUP screen.

4-3-3 Delete a Group

GROUP SETUP
MANUAL NEW
> FISHER2
FRIENDS1

FISHER2
EDIT
> DELETE

DELETE GROUP
FISHER2
> YES
NO

1. Select DSC SETUP, then GROUP SETUP. The existing group names are displayed.
2. Press + or - to scroll to the incorrect entry then press ENT.
3. Select DELETE and press ENT. The radio asks for confirmation.
4. Press ENT to delete the group and return to the GROUP SETUP screen.

4-4 Response to Individual Calls (INDIV REPLY)

VHF 710US only. You can respond to incoming individual calls with an automatic response or with a manual response.

An automatic response sends an acknowledgement and then sets the request link channel, ready for a conversation.

A manual response asks if you want to acknowledge the call, and then asks if you want to converse with the caller.

DSC SETUP
USER MMSID
GROUP SETUP
> INDIV REPLY

INDIV REPLY
> AUTO
MANUAL

1. Select DSC SETUP, then INDIV REPLY.
2. Select AUTO for an automatic response, or MANUAL for a manual response.

3. Press ENT to confirm your choice and return to the menu.

4-5 ATIS MMSID & ATIS Functionality

VHF 710EU only. You must enter your ATIS MMSID to access ATIS functionality if you are navigating inland waterways within Europe.

ATIS sends a digital message anytime that you release the PTT key. Inland waterways rules require 1 W Tx power on Channels 06, 08, 10, 11, 12, 13, 14, 15, 17, 71, 72, 74, and 77.

4-5-1 Enter or Edit YOUR ATIS MMSID

DSC SETUP
GROUP SETUP
INDIV REPLY
> ATIS MMSID

INPUT ATIS
MMSID
9-----

INPUT ATIS
MMSID
> STORE
CANCEL

INPUT AGAIN
ATIS MMSID
9-----

ATIS MMSID
923456789
> STORE
CANCEL

VHF 710EU only. An ATIS MMSID always starts with the number 9. To enter or edit your ATIS MMSID:

1. Select DSC SETUP, then ATIS MMSID.
2. If this is the first time that you are entering your ATIS MMSID, a dashed line appears. Enter your ATIS MMSID along the dashed line. The first number is always 9. Press ENT to confirm each correct entry and to move to the next digit.

If you make an error, press - until < appears, then press ENT to backup and correct the entry.

If you are editing an existing ATIS MMSID, this will be displayed. Make the required changes.

3. Press ENT to store your user MMSID.
4. Enter your ATIS MMSID again as a password check, then press ENT to permanently store the ATIS MMSID and return to the menu.

You can view your stored ATIS MMSID at anytime by selecting ATIS MMSID in the main menu.

4-5-2 Enable ATIS Functionality (ATIS FUNC)

VHF 710EU only. ATIS functionality will operate only after the ATIS MMSID has been entered (see previous section).

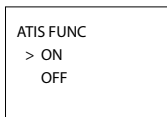
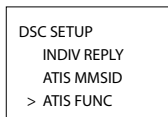

1. Select DSC SETUP, then ATIS FUNC.
2. Select ON (on) to enable the ATIS functionality and automatically disable DSC functionality. The ATIS annunciator appears on the screen.

It is not possible to have both ATIS ON (on) and DSC ON (on) simultaneously. When you enable one, the other will turn OFF (off). If DSC and ATIS are both OFF (off), DSC will have to be switched ON (on) for normal DSC operation.

There are two annunciators in the screen to show you the current mode: if the DSC annunciator is shown, DSC is operational, if the ATIS annunciator is shown, ATIS is operational.

4-6 DSC functionality options (DSC FUNC)

DSC functionality can be disabled but this is not recommended.

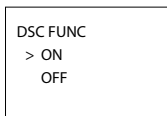
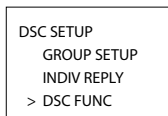

1. Select DSC SETUP, then DSC FUNC.
2. Press ENT to select ON and to operate the DSC functionality. This will automatically disable ATIS functionality. The DSC annunciator appears on the screen.

It is not possible to have both ATIS ON (on) and DSC ON (on) simultaneously. When you enable one, the other will turn OFF (off). If DSC and ATIS are both OFF (off), DSC will have to be switched ON (on) for normal DSC operation.

There are two annunciators in the screen to show you the current mode: if the DSC annunciator is shown, DSC is operational. If the ATIS annunciator is shown, ATIS is operational.

4-7 Response Type to LL Polling Calls (LL REPLY)

You can set up the radio to respond to an LL polling request in one of three ways:

AUTO automatically replies to any incoming LL polling requests from any of your buddies.

MANUAL choose whether to reply automatically or manually to any incoming buddy polling requests.

OFF ignores all incoming buddy LL polling requests.

```
DSC SETUP
  INDIV REPLY
  DSC FUNC
> LL REPLY
```

```
LL REPLY
> AUTO
  MANUAL
  OFF
```

1. Select DSC SETUP, then LL REPLY.
2. Select your response and press ENT to confirm and return to the menu.

Section 5 - Sending and Receiving DSC Calls

These DSC facilities are available only on the VHF 710US and VHF 710EU models, and a valid user MMSID must have been entered to access the DSC functions.

5-1 WHAT IS DSC?

DSC (Digital Selective Calling) is a semi-automated method of establishing VHF, MF, and HF radio calls. It has been designated as an international standard by the IMO (International Maritime Organization) and is part of the GMDSS (Global Maritime Distress and Safety System).

Currently, you are required to monitor Distress Channel 16, but DSC will eventually replace listening watches on distress frequencies and will be used to broadcast routine and urgent maritime safety information.

DSC enables you to send and receive calls from any vessel or coast station that is equipped with DSC functionality, and within geographic range. Calls can be categorised as distress, urgency, safety, or routine, and DSC selects a working channel automatically.

5-2 Sending DSC calls

DSC CALL
>INDIVIDUAL
LAST CALL
GROUP

1. Press CALL MENU to show the types of DSC call that can be made.
Note: Only four DSC call types can be shown at any one time on the screen.
2. + or - to scroll up and down the DSC call types until the cursor is positioned at the desired option. then press ENT. the DSC call types are:

INDIVIDUAL	Make a routine call or acknowledgement to a new caller or a buddy. See Section 5-2-1, 5-2-2, and 5-2-3. Show the details of the most recent incoming call.
LAST CALL	See Section 5-2-4. Make a call to one of your three groups.
GROUP	See Section 5-2-5. Make an All Ships call.
ALL SHIPS	See Section 5-2-6. Show the details of the 20 most recent incoming calls.
CALL LOG	See Section 5-2-7. Show the details of the 10 most recent distress calls.
DIST LOG	See Section 5-2-8. Request the LL position of a buddy.
LL REQUEST	See Section 5-2-9.

5-2-1 Make a Routine Call (Individual)

DSC CALL
> INDIVIDUAL
LAST CALL
GROUP

INDIVIDUAL
> MANUAL NEW
BOBBY D
REBECCA T

MANUAL MMSID
0-----

012345678
INDIVIDUAL
ROUTINE
> SET CHANNEL

012345678
INDIVIDUAL
ROUTINE
> SEND?

12345678
INDIVIDUAL
ROUTINE
CALLING...

012345678
INDIVIDUAL
ROUTINE
WAITING ACK

INDIV ACK
012345678
PRESS PTT
ESC -> EXIT

You can call any other person that has another DSC equipped radio.

1. Press CALL/MENU to enter DSC mode, then select INDIVIDUAL. This allows you to call another person.
2. Select MANUAL NEW to call a person that is not in your buddy list, otherwise select the name of your buddy. Press ENT.

If you selected MANUAL NEW, you need to enter the user MMSID and then press ENT.

3. Select the working channel and press ENT. (**Note:** Duplex channels cannot usually be called and are automatically eliminated from the suggested call list. If the call is to a Coast Station, the radio will recognize this and select the correct channel.)
4. The radio summarizes the call details and asks for confirmation to send the call (SEND?). Press ENT to send the call. The radio goes to CH70 and the TX annunciator is displayed on the screen while the DSC call is being sent.
5. If the call is acknowledged (ACK), press PTT to talk. If there is no reply, retry making the call. See Section 5-2-2.

5-2-2 Retrying a Routine Call

VHF710
SEND AGAIN?
>YES
CANCEL

1. If there is no reply to your call after one minute (UNABLE TO ACKNOWLEDGE) the radio asks if you want to retry the call (SEND AGAIN?).
2. Select YES and press ENT to retry the call.
The radio will repeat this cycle twice. If the call still cannot be placed, the radio returns to normal operation.

5-2-3 Acknowledgement of an Individual Incoming Call (INDIV)

RCV: INDIV
012345678
ENTER -> ACK
ESC -> EXIT

The VHF 710EU requires the operator to manually send an acknowledgement to the requesting radio.

Press ENT to send an acknowledgement or ESC to cancel.

The VHF 710US will automatically send an acknowledgement to the requesting radio within 10 seconds of receiving the call.

Note: For some Countries in Europe it is possible to select ROUTINE, SAFETY, URGENCY, and DISTRESS as the call category for Individual call transmissions.

5-2-4 Recall the Most Recent Incoming Call (LAST)

DSC CALL
INDIVIDUAL
> LAST CALL
GROUP

VHF710 USA
INDIVIDUAL
ROUTINE
10:22AM LOC

VHF710 USA
INDIVIDUAL
ROUTINE
> SET CHANNEL

VHF710 USA
INDIVIDUAL
ROUTINE
> SEND?

This facility is useful and used frequently.

1. Press CALL/MENU to enter DSC mode. LAST CALL is automatically selected. Press ENT to display the contact details of the most recent incoming call.
2. Select the working channel and press ENT. (**Note:** Duplex channels cannot usually be called and are automatically eliminated from the suggested call list. If the call is to a Coast Station, the radio will recognize this and select the correct channel.)
3. The radio summarizes the call details and asks for confirmation to send the call (SEND?). Press ENT to send the call, and continue as explained in Section 5-2-1.

5-2-5 Call a Group (GROUP)

DSC CALL
INDIVIDUAL
LAST CALL
> GROUP

SELECT GROUP
> RD GROUP
GROUP #2
GROUP#3

RD GROUP
055554444
ROUTINE
> SET CHANNEL

VHF710 USA
INDIVIDUAL
ROUTINE
> SEND?

1. Press CALL MENU to enter DSC mode, then select GROUP. The radio displays the names of your groups.
2. Select the group that you want to call (the Group MMSID must be set before making the call). Then set the channel and continue as explained in Section 5-2-1.

5-2-6 Call All Ships (ALL SHIPS)

DSC CALL
LAST CALL
GROUP
> ALL SHIPS

ALL SHIPS
> URGENCY
SAFETY
ROUTINE

ALL SHIPS
URGENCY
> YES
NO

The ALL SHIPS ROUTINE call option is shown only on the VHF 710US.

1. Press CALL MENU to enter DSC mode, then select ALL SHIPS.
2. The priority is set automatically to URGENCY. However, you can select one of the following call priorities:

URGENCY
SAFETY
ROUTINE
DISTRESS

For use when a serious situation or problem arises that could lead to a distress situation
To send safety information to all other vessels in range;
Routine call (VHF 710US only).
Used in some countries in Europe

3. CH16 is selected automatically as the working channel and the radio asks for confirmation of the ALL SHIPS call. Press ENT to select YES and send the call. Continue as explained in Section 5-2-1.

5-2-7 Call using the Call Log (CALL LOG)

DSC CALL
GROUP
ALL SHIPS
> CALL LOG

11 VHF710
INDIVIDUAL
ROUTINE
10:45PM LOC

VHF710
> CALL BACK
DELETE
SAVE

VHF710
INDIVIDUAL
ROUTINE
> SET CHANNEL

VHF710
INDIVIDUAL
ROUTINE
> SEND?

The Call Log contains the contact details for the 20 most recent incoming calls, so that you call any of them again quickly.

1. Press CALL MENU to enter DSC mode, then select CALL LOG.
Scroll down to the desired contact details.
The radio displays the contact details for the most recent incoming call as the first entry (01) in the call log. In the example, the contact details for the 11th most recent call are displayed.
2. Press ENT to confirm the call back, then set the working channel and press ENT to send the call. Continue as explained in Section 5-2-1.
3. To save this log entry in your Buddy list, select SAVE and press ENT. Then enter the Name. The logged MMSID is automatically displayed.

5-2-8 Call using the Distress Log (DIST LOG)

DSC CALL
ALL SHIPS
CALL LOG
> DIST LOG

02 10:03 UTC
VHF710 (xxx)
82°50. N
27°45. W

DISTRESS
RELAY
PIRACY
987654321

VHF710
> CALL BACK
DELETE

VHF710
INDIVIDUAL
ROUTINE
> SET CHANNEL

VHF710
INDIVIDUAL
ROUTINE
> SEND?

Note: DISTRESS RELAY calls can be sent in some countries.

The Distress Log contains the Distress Log data for the 10 most recent relayed Distress Calls, so that you can call any of them quickly. LL position is received to 3 decimal places, if the sending radio is qualified. Always try to make voice contact on CH16 first, as follows:

1. Press CALL/MENU to enter DSC mode, then select DIST LOG.
2. The most recently received Distress Call is the first entry (01) in the Distress Log. Select the entry that you want to call and press ENT.
The details are displayed over two screens that alternate every 1.5 seconds; the first screen shows the location and name or MMSID of the vessel in Distress, the second screen shows the nature of the emergency (if specified) and the MMSID of the vessel that relayed the Distress Call.
3. Set the channel and continue as explained in Section 5-2-1.

5-2-9 Request the LL Position of a Buddy (LL REQUEST)

DSC CALL
CALL LOG
DIST LOG
> LL REQUEST

LL REQUEST
> SAM
VHF710
BUDDY #3

SAM
LL REQUEST
> SEND?

SAM
LL REQUEST

CALLING...

channel name
SAM
LL REQUEST
AWAITING ACK

1. Press CALL/MENU to enter DSC mode, then select LL REQUEST.
2. Select the buddy whose LL position you want to request then press ENT to send the request. (See Section 5-3-5 for the acknowledgement.)
3. The working channel name is displayed while the radio waits for an acknowledgement from your buddy. If there is no reply after 1 minute the radio asks if you want to retry. Continue as explained in Section 5-2-2.

5-3 Receiving DSC Calls

Several types of DSC calls can be received from vessels within range at various priority levels:

DISTRESS	See Section 6.
ALL SHIPS	Urgency or Safety priority (see Section 5-3-1) Note: In some countries, ALL SHIP DISTRESS calls are received.
INDIVIDUAL	Urgency, Safety, or Routine priority (see Section 5-3-2) Note: In some countries, INDIVIDUAL DISTRESS RELAY calls are received.
GROUP	Routine priority only (see Section 5-3-3)
GEOGRAPHIC	Routine priority only (see Section 5-3-4)
POLLED POSITION	Routine priority only (see Section 5-3-5)

In addition to the audible alert, the telephone icon will flash on the screen.

5-3-1 Receiving an All Ships Call (ALL SHIPS)

RCV: ALL SHIP
priority
VHF710
ESC -> EXIT

1. When you receive notification of an ALL SHIP call, press any key to cancel the alert. The radio automatically selects CH16.

The priority level and the user MMSID are displayed on the screen. If the radio recognises the user MMSID as one of your buddies, the buddy's name is displayed in place of the user MMSID.
2. No acknowledgement is required. Press PTT to initiate voice contact on CH16 and then switch to a working channel.

The call data is stored in the Call Log (see Section 5-2-7).

5-3-2 Receiving an Individual Call (INDIV)

RCV: INDIV
VHF710
ENTER -> ACK
ESC -> EXIT

INDIV ACK
VHF710
PRESS PTT
ESC -> EXIT

1. When you receive notification of an INDIV call, press any key to cancel the alert. The radio automatically selects the channel designated in the incoming call. INDIV calls are almost always Routine priority.

If the radio recognises the user MMSID as one of your buddies, the buddy's name is displayed in place of the user MMSID.

2. The VHF 710US responds automatically but the VHF 710EU prompts you to press ENT to acknowledge the incoming call.
3. The caller should respond to your acknowledgement by making voice contact on the designated channel. If this does not happen, you can press PTT to initiate voice contact instead.

The call data is stored in the Call Log (see Section 5-2-7).

5-3-3 Receiving a Group Call (GROUP)

RCV: GROUP
GP: RD GROUP
VHF710
ROUTINE

1. When you receive notification of a GROUP call, press any key to cancel the alert. The radio automatically selects the channel designated in the incoming call.

The priority level is always routine, and the group is identified on the screen. The group will be one of the three groups of frequently called people that you set up earlier (see Section 4-3).

2. You do not need to send an acknowledgement. If desired, press PTT to initiate voice contact on the designated channel.

The call data is stored in the Call Log (see Section 5-2-7).

5-3-4 Receiving a Geographic Call (GEOGRAPH)

RCV: GEOGRAPH
SAM
VHF710
10:34 UTC
ESC -> EXIT

A geographic call is received by vessels within a specific geographic boundary area.

1. When you receive notification of a GEOGRAPH call, press any key to cancel the alert. The radio automatically selects the channel designated in the incoming call.

The time and the user MMSID or name are displayed on the screen. If the radio recognises the user MMSID as one of your buddies, the buddy's name is displayed in place of the user MMSID.

2. Monitor the working channel for an announcement from the calling vessel.

5-3-5 Receiving a Polled Position Call (POSITION)

RCV: POSITION
SAM
82°50.003'N
27°45.543'W

1. When you receive GPS position data from a buddy in response to your LL request (see Section 5-2-9), you are recommended to make a written note of the position, especially if it is a good fishing position.

If enhanced LL position information is available from your buddy, this is shown on the screen until the screen display changes.

Section 6 - Distress Calls

This DSC function is available only on the 710US and 710EU models, and a valid user MMSID must have been entered to access this DSC function.

6-1 Sending a Distress Call

DISTRESS CALL
> PIRACY
OVER BOARD
UNDEFINED

DISTRESS CALL
> PIRACY
HOLD DISTRESS
2 SECONDS..

DISTRESS CALL
SENT! WAIT..
PRESS ESC
TO CANCEL...

1. Open the red cover labelled DISTRESS.
If time is available to specify the nature of the distress, go to step 2. Otherwise, go directly to step 3.
2. Press the DISTRESS key to display the following categories. Scroll to the category that describes your situation, then press ENT:

UNDEFINED
FIRE
FLOODING
COLLISION
GROUNDING
LISTING
SINKING
ADRIFT
ABANDONING
PIRACY
OVER BOARD

3. Hold down the DISTRESS key for about 3 seconds, until you see the distress call sent message (DISTRESS CALL SENT!) on the screen. The whole display starts to flash and beep loudly.

The distress call repeats five times continuously. It then repeats randomly every 3.5 to 4.5 minutes until a distress acknowledgement (DISTRESS ACK) is received from a search and rescue authority or until you cancel the distress call manually.

The radio selects CH16 automatically so that you can hear any incoming voice contacts from search and rescue authorities or other vessels within range.

Press ESC if you need to cancel the distress call. This is the only key that operates in distress mode.

6-2 Receiving a Distress Call (DISTRESS!)

RCV: DISTRESS
123456789
FLOODING
ESC -> EXIT

RCV: DISTRESS
10:34 UTC
82°50.003'N
27°45.543'W

1. An alert sounds when a distress call (DISTRESS!) is received. Press any key to cancel the alert. You do not need to send an acknowledgement.

2. The radio automatically selects CH16 and displays the details of the distress call on the screen. Press PTT to establish voice contact.

The details are displayed over two screens that alternate every 1.5 seconds; the first screen shows the user MMSID and nature of the emergency (if specified), the second screen shows the time and the location (if specified). If the location and time are not specified, these are replaced with sequences of 9s and 8s respectively.

The VHF710 is capable of receiving enhanced LL position data if the vessel transmitting the Distress Call is sending this. This provides the position of the distressed vessel to within 20 m (60ft).

6-3 Distress Acknowledgement (distress ack) or Relay

RCV: DISTRESS
RELAY
123456789
ESC -> EXIT

An alert sounds when a Distress Relay (DISTRESS RELAY) is received. Press any key to cancel the alert.

Try to make voice contact with the calling vessel. Maintain a listening watch on CH16 and standby to lend assistance.

For a Distress Acknowledgement (DISTRESS ACK) sent from the Coast Guard, your radio automatically cancels Distress Mode transmissions and CH16 appears. Press PTT to establish voice contact with the Coast Guard. The Coast Guard is the only agency allowed to send a Distress Acknowledgement (DISTRESS ACK).

Appendix A - Technical Specifications

Northstar VHF 710 US.EU

GENERAL

Power Supply:	13.6V DC.
Current drain:	
Transmit	6 A at 25 W Tx / 1.5A at 1W Tx
Receive	Less than 250mA in standby
Useable channels:	International, USA, Canada, Weather (country specific)
Mode:	16K0G3E (FM) / 16K0G2B (DSC)

PHYSICAL

LCD display (viewing):	26 mm (H) x 46 mm (W) FSTN 4 x 12 character matrix with big CH digits/icons
------------------------	--

Contrast and

Dimming control:	Yes
Antenna connector:	SO-239 (50 ohm)
Temperature Range:	-15°C to +50°C
Waterproof:	JIS-7
Dimensions:	161(W) x 75(H) x 147(D) mm - without bracket
Weight:	1.29 kg (2.8 lbs) - without microphone
Frequency stability:	+/- 10ppm
Frequency control:	PLL
GPS/NMEA input:	Yes
Comm. port:	4800 baud NMEA
DSC:	Yes

FEATURES

Flush Mount kit and dust cover:	Yes
Local/Distant control:	Yes
Position polling:	Yes
Group Call:	Yes
Call logs:	Yes - 20 individual and 10 distress
DSC (USCG SC101 and Class D):	Yes (VHF 710US, Class D 710EU)
Channel Naming:	Yes
Tri watch, Favourite channel scan, All scan:	Yes
User programmable MMSID:	Yes, User MMSID and ATIS (710EU)
MMSID and NAME directory:	Yes - 20 numbers & group

TRANSMITTER

Frequency:	156.025 - 157.425 MHz
Output power:	25 W / 1 W selectable
Transmitter protection:	Open / short circuit of antenna
Max Freq deviation:	+/- 5 kHz
Spurious & harmonics:	better than 2.5 μ W
Modulation distortion:	Less than 4%@ 1 kHz for a +/-3 kHz deviation

RECEIVER

Frequency:	156.025 - 163.275 MHz
12 dB SINAD sensitivity:	0.25 μ V (distant) / 2.5 μ V (local)
20 db SINAD sensitivity:	0.35 μ V
Adjacent CH selectivity:	more than 70 db (VHF 710US) more than 70 db (VHF 710EU)
Spurious response:	more than 70 db (VHF 710US) more than 70 db (VHF 710EU)
Intermodulation	
Rejection ratio:	more than 68 db (VHF 710US) more than 68 db (VHF 710EU)
Residual Noise level:	more than -40 db unsquelched
Audio output power:	2 W (with 8 ohm at 10% distortion) 4 W with 4 ohm external speaker
Compass safe distance:	0.5 m (1.5')

Specifications are subject to change without notice.

Appendix B - Troubleshooting

1. The transceiver will not power up.

A fuse may have blown OR there is no voltage getting to the transceiver.

- a) Check the power cable for cuts, breaks, or squashed sections.
- b) After checking the wiring, replace the 7 Amp fuse (2 spare fuses are supplied).
- c) Check the battery voltage. This must be greater than 10.5 V.

2. The transceiver blows the fuse when the power is switched on.

The power wires may have been reversed.

- a) Check that the red wire is connected to the positive battery terminal, and the black wire is connected to the negative battery terminal.

3. The speaker makes popping or whining noises when the engine is running.

Electrical noise may be interfering with the transceiver.

- a) Re-route the power cables away from the engine.
- b) Add a noise suppressor to the power cable.
- c) Use resistive spark plug wires and/or use an alternator whine filter.

4. No sound from the external speaker.

- a) Check that the external speaker cable is physically connected.
- b) Check the soldering of the external speaker cable.

5. Transmissions are always on low power, even when high (HI) power is selected.

The antenna may be faulty.

- a) Test the transceiver with a different antenna.
- b) Have the antenna checked out.

6. Battery symbol is displayed.

The power supply is too low.

- a) Check the battery voltage. This should be at least 10.5 V \pm 0.5 V DC.
- b) Check the alternator on the vessel.

7. No position information is displayed.

The GPS cable may be faulty or the GPS setting may be incorrect.

- a) Check that the GPS cable is physically connected.
- b) Check the polarity of the GPS cable.
- c) Check the baud rate setting of the GPS if applicable. The baud rate setting should be 4800 and parity should be set to NONE.

Appendix C - VHF Marine Channel Charts

C.1 International (EU-DSC ON)

NOTE For assistance in understanding the Table, see notes a) to o) below. (WRC-2000)

Channel designator	Notes	Transmitting frequencies MHz		Inter-ship	Port operations and ship movement		Public correspondence
		Ship stations	Coast stations		Single frequency	Two frequency	
60		156,025	160,625			x	x
01		156,050	160,650			x	x
61	m), o)	156,075	160,675		x	x	x
02	m), o)	156,100	160,700		x	x	x
62	m), o)	156,125	160,725		x	x	x
03	m), o)	156,150	160,750		x	x	x
63	m), o)	156,175	160,775		x	x	x
04	m), o)	156,200	160,800		x	x	x
64	m), o)	156,225	160,825		x	x	x
05	m), o)	156,250	160,850		x	x	x
65	m), o)	156,275	160,875		x	x	x
06	f)	156,300		x			
66		156,325	160,925			x	x
07		156,350	160,950			x	x
67	h)	156,375	156,375	x	x		
08		156,400		x			
68		156,425	156,425		x		
09	i)	156,450	156,450	x	x		
69		156,475	156,475	x	x		
10	h)	156,500	156,500	x	x		
70	j)	156,525	156,525	Digital selective calling for distress, safety and calling			
11		156,550	156,550		x		
71		156,575	156,575		x		
12		156,600	156,600		x		
72	i)	156,625		x			
13	k)	156,650	156,650	x	x		
73	h), i)	156,675	156,675	x	x		
14		156,700	156,700		x		
74		156,725	156,725		x		
15	g)	156,750	156,750	x	x		
75	n)	156,775			x		

Channel designator	Notes	Transmitting frequencies MHz		Inter-ship	Port operations and ship movement		Public correspondence
		Ship stations	Coast stations		Single frequency	Two frequency	
16		156,800	156,800		DISTRESS, SAFETY AND CALLING		
76	<i>n)</i>	156,825			x		
17	<i>g)</i>	156,850	156,850	x	x		
77		156,875		x			
18	<i>m)</i>	156,900	161,500		x	x	x
78		156,925	161,525			x	x
19		156,950	161,550			x	x
79		156,975	161,575			x	x
20		157,000	161,600			x	x
80		157,025	161,625			x	x
21		157,050	161,650			x	x
81		157,075	161,675			x	x
22	<i>m)</i>	157,100	161,700		x	x	x
82	<i>m), o)</i>	157,125	161,725		x	x	x
23	<i>m), o)</i>	157,150	161,750		x	x	x
83	<i>m), o)</i>	157,175	161,775		x	x	x
24	<i>m), o)</i>	157,200	161,800		x	x	x
84	<i>m), o)</i>	157,225	161,825		x	x	x
25	<i>m), o)</i>	157,250	161,850		x	x	x
85	<i>m), o)</i>	157,275	161,875		x	x	x
26	<i>m), o)</i>	157,300	161,900		x	x	x
86	<i>m), o)</i>	157,325	161,925		x	x	x
27		157,350	161,950			x	x
87		157,375			x		
28		157,400	162,000			x	x
88		157,425			x		
AIS 1	<i>l)</i>	161,975	161,975				
AIS 2	<i>l)</i>	162,025	162,025				

SPECIAL NOTES ON INTERNATIONAL CHANNEL USAGE

Notes referring to the Table

General notes

The International mode is not legal for use in US or Canada Waters

- Administrations may designate frequencies in the inter-ship, port operations and ship movement services for use by light aircraft and helicopters to communicate with ships or participating coast stations in predominantly maritime support operations under the conditions specified in Nos. 51.69, 51.73, 51.74, 51.75, 51.76, 51.77 and 51.78. However, the use of the channels which are shared with public correspondence shall be subject to prior agreement between interested and affected administrations.
- The channels of the present Annex, with the exception of channels 06, 13, 15, 16, 17, 70, 75 and 76, may also be used for high-speed data and facsimile transmissions, subject to special arrangement between interested and affected administrations.
- The channels of the present Annex, but preferably channel 28 and with the exception of channels 06, 13, 15, 16, 17, 70, 75 and 76, may be used for direct-printing telegraphy and data transmission, subject to special arrangement between interested and affected administrations.

- d. The frequencies in this Table may also be used for radiocommunications on inland waterways in accordance with the conditions specified in No. 5.226. – 56 – 62238 IEC:2003(E)
- e. Administrations having an urgent need to reduce local congestion may apply 12,5 kHz channel interleaving on a non-interference basis to 25 kHz channels, provided:
 - Recommendation ITU-R M.1084-2 shall be taken into account when changing to 12,5 kHz channels;
 - it shall not affect the 25 kHz channels of the present Annex maritime mobile distress and safety frequencies, especially the channels 06, 13, 15, 16, 17, and 70, nor the technical characteristics mentioned in Recommendation ITU-R M.489-2 for those channels;
 - implementation of 12,5 kHz channel interleaving and consequential national requirements shall be subject to prior agreement between the implementing administrations and administrations whose ship stations or services may be affected.

Specific notes

- f. The frequency 156,300 MHz (channel 06) (see No. 51.79 and Appendices 13 and 15) may also be used for communication between ship stations and aircraft stations engaged in coordinated search and rescue operations. Ship stations shall avoid harmful interference to such communications on channel 06 as well as to communications between aircraft stations, ice-breakers and assisted ships during ice seasons.
- g. Channels 15 and 17 may also be used for on-board communications provided the effective radiated power does not exceed 1 W, and subject to the national regulations of the administration concerned when these channels are used in its territorial waters.
- h. Within the European Maritime Area and in Canada, these frequencies (channels 10, 67, 73) may also be used, if so required, by the individual administrations concerned, for communication between ship stations, aircraft stations and participating land stations engaged in coordinated search and rescue and anti-pollution operations in local areas, under the conditions specified in Nos. 51.69, 51.73, 51.74, 51.75, 51.76, 51.77 and 51.78.
- i. The preferred first three frequencies for the purpose indicated in Note a) are 156,450 MHz (channel 09), 156,625 MHz (channel 72) and 156,675 MHz (channel 73).
- j. Channel 70 is to be used exclusively for digital selective calling for distress, safety and calling.
- k. Channel 13 is designated for use on a worldwide basis as a navigation safety communication channel, primarily for intership navigation safety communications. It may also be used for the ship movement and port operations service subject to the national regulations of the administrations concerned.
- l. These channels (AIS 1 and AIS 2) will be used for an automatic ship identification and surveillance system capable of providing worldwide operation on high seas, unless other frequencies are designated on a regional basis for this purpose.
- m. These channels may be operated as single frequency channels, subject to special arrangement between interested or affected administrations. (WRC-2000)
- n. The use of these channels (75 and 76) should be restricted to navigation-related communications only and all precautions should be taken to avoid harmful interference to channel 16, e.g. by limiting the output power to 1 W or by means of geographical separation.
- o. These channels may be used to provide bands for initial testing and the possible future introduction of new technologies, subject to special arrangement between interested or affected administrations. Stations using these channels or bands for the testing and the possible future introduction of new technologies shall not cause harmful interference to, and shall not claim protection from, other stations operating in accordance with Article 5. (WRC-2000)

C.2 USA Channel Chart

CH	SEND (MHz)	RECEIVE (MHz)	TRAFFIC TYPE	SHIP TO SHIP	SHIP TO SHORE	NAME TAG
01A	156.050	156.050	Port Operations, Selected VTS Areas	Yes	Yes	PORT OPS/VTS
03A ⁴	156.150	156.150	US Government, Coast Guard	Yes	Yes	UNAUTHORIZED
05A	156.250	156.250	Port Operations, Selected VTS Areas	Yes	Yes	PORT OPS/VTS
06	156.300	156.300	Inter-ship Safety	Yes	No	SAFETY
07A	156.350	156.350	Commercial	Yes	Yes	COMMERCIAL
08	156.400	156.400	Commercial (inter-ship only)	Yes	No	COMMERCIAL
09	156.450	156.450	Recreational Calling Channel	Yes	Yes	CALLING
10	156.500	156.500	Commercial	Yes	Yes	COMMERCIAL
11	156.550	156.550	Commercial, VTS in Selected Areas	Yes	Yes	VTS
12	156.600	156.600	Port Operations, Selected VTS Areas	Yes	Yes	PORT OPS/VTS
13 ³	156.650	156.650	Intership Navigation Safety (bridge-to-bridge), 1W with Power-up	Yes	No	BRIDGE COM
14	156.700	156.700	Port Operations, Selected VTS Areas	Yes	Yes	PORT OPS/VTS
15 ²	RX Only	156.750	Environmental, RX Only	-----	-----	ENVIROMENTAL
16	156.800	156.800	International Distress, Safety, and Calling	Yes	Yes	DISTRESS
17 ¹	156.850	156.850	State Controlled – 1W Only	Yes	Yes	SAR
18A	156.900	156.900	Commercial	Yes	Yes	COMMERCIAL
19A	156.950	156.950	Commercial	Yes	Yes	COMMERCIAL
20	157.000	161.600	Port Operations, Canadian Coast Guard, Duplex	No	Yes	PORT OPS
20A	157.000	157.000	Port Operations	Yes	Yes	PORT OPS
21A ⁴	157.050	157.050	U.S. Government, Canadian Coast Guard	Yes	Yes	UNAUTHORIZED
22A	157.100	157.100	Coast Guard Liaison	Yes	Yes	COAST GUARD
23A ⁴	157.150	157.150	U.S. Government, Coast Guard	Yes	Yes	UNAUTHORIZED
24	157.200	161.800	Public Correspondence, Marine Operator	No	Yes	TELEPHONE
25	157.250	161.850	Public Correspondence, Marine Operator	No	Yes	TELEPHONE
26	157.300	161.900	Public Correspondence, Marine Operator	No	Yes	TELEPHONE
27	157.350	161.950	Public Correspondence, Marine Operator	No	Yes	TELEPHONE
28	157.400	162.000	Public Correspondence, Marine Operator	No	Yes	TELEPHONE

CH	SEND (MHz)	RECEIVE (MHz)	TRAFFIC TYPE	SHIP TO SHIP	SHIP TO SHORE	NAME TAG
61A ⁴	156.075	156.075	U.S. Government, Canadian Coast Guard	Yes	Yes	UNAUTHORIZED
63A	156.175	156.175	Port Operations, VTS in Selected Areas	Yes	Yes	PORT OPS/VTS
64A ⁴	156.225	156.225	U.S. Government, Canadian Commercial Fishing	Yes	Yes	UNAUTHORIZED
65A	156.275	156.275	Port Operations	Yes	Yes	PORT OPS
66A	156.325	156.325	Port Operations	Yes	Yes	PORT OPS
67 ³	156.375	156.375	Commercial, bridge-to-bridge, 1W with Power-up	Yes	No	BRIDGE COM
68	156.425	156.425	Boat Operations, Recreational	Yes	No	SHIP - SHIP
69	156.475	156.475	Boat Operations, Recreational	Yes	Yes	PLEASURE
70 ⁶	156.525	156.525	Digital Selective Calling - DSC	-----	-----	DSC
71	156.575	156.575	Boat Operations, Recreational	Yes	Yes	PLEASURE
72	156.625	156.625	Boat Operations, Recreational	Yes	No	SHIP - SHIP
73	156.675	156.675	Port Operations	Yes	Yes	PORT OPS
74	156.725	156.725	Port Operations	Yes	Yes	PORT OPS
77 ¹	156.875	156.875	Port Operations –1W Only	Yes	Yes	PORT OPS
78A	156.925	156.925	Boat Operations, Recreational	Yes	No	SHIP - SHIP
79A	156.975	156.975	Commercial	Yes	Yes	COMMERCIAL
80A	157.025	157.025	Commercial	Yes	Yes	COMMERCIAL
81A ⁴	157.075	157.075	U.S. Government, Environmental Protection Agency Operations	Yes	Yes	UNAUTHORIZED
82A ⁴	157.125	157.125	U.S. Government, Canadian Coast Guard	Yes	Yes	UNAUTHORIZED
83A ⁴	157.175	157.175	U.S. Government, Canadian Coast Guard	Yes	Yes	UNAUTHORIZED
84	157.225	161.825	Public Correspondence, Marine Operator	No	Yes	TELEPHONE
85	157.275	161.875	Public Correspondence, Marine Operator	No	Yes	TELEPHONE
86	157.325	161.925	Public Correspondence, Marine Operator	No	Yes	TELEPHONE
87	157.375	161.975	Public Correspondence, Marine Operator	No	Yes	TELEPHONE
88	157.425	162.025	Public Correspondence, Marine Operator	No	Yes	TELEPHONE
88A	157.425	157.425	Commercial, Intership Only	Yes	No	COMMERCIAL

WEATHER		MHz	TRAFFIC TYPE			NAME TAG
Wx01	RX Only	162.550	NOAA WEATHER CHANNEL	-----	-----	NOAA WX
Wx02	RX Only	162.400	NOAA WEATHER CHANNEL	-----	-----	NOAA WX
Wx03	RX Only	162.475	NOAA WEATHER CHANNEL	-----	-----	NOAA WX
Wx04	RX Only	162.425	NOAA WEATHER CHANNEL	-----	-----	NOAA WX
Wx05	RX Only	162.450	NOAA WEATHER CHANNEL	-----	-----	NOAA WX
Wx06	RX Only	162.500	NOAA WEATHER CHANNEL	-----	-----	NOAA WX
Wx07	RX Only	162.525	NOAA WEATHER CHANNEL	-----	-----	NOAA WX
Wx08	RX Only	161.650	CANADIAN WEATHER CHANNEL	-----	-----	CANADA WX
Wx09	RX Only	161.775	CANADIAN WEATHER CHANNEL	-----	-----	CANADA WX
Wx10	RX Only	163.275	NOAA WEATHER CHANNEL	-----	-----	NOAA WX

SPECIAL NOTES ON USA CHANNEL USAGE

1. LOW POWER (1 W) only.
2. Receive Only.
3. LOW POWER (1 W) initially. Override to HIGH POWER by holding down H/L key before transmitting. Used normally in bridge-to-bridge communications.
4. Lightly Shaded Simplex channels 03A, 21A, 23A, 61A, 64A, 81A, 82A, and 83A cannot be lawfully used in U.S. waters unless special authorization is obtained from the U.S. Coast Guard. Not for use by the general public.
5. The letter "A" illuminated by the channel number indicates the USA channel is simplex. This same channel is always duplex when selecting International. There is no "A" reference for International channels. The letter "B" is only used for some Canadian "Receive Only" channels.
6. Channel 70 is designated for use exclusively for Digital Selective Calling (DSC), such as Distress, Safety, and Ship Calls. No voice communication is allowed on CH70.

C-3 CANADA Channel CHART

CH	SEND (MHz)	RECEIVE (MHz)	TRAFFIC TYPE	SHIP TO SHIP	SHIP TO SHORE	NAME TAG
01	156.050	160.650	Public Correspondence, Duplex	No	Yes	TELEPHONE
02	156.100	160.700	Public Correspondence, Duplex	No	Yes	TELEPHONE
03	156.150	160.750	Public Correspondence, Duplex	No	Yes	TELEPHONE
04A	156.200	156.200	Canadian Coast Guard, SAR	Yes	Yes	CANADIAN CG
05A	156.250	156.250	Port Operations, VTS in Selected Areas	Yes	Yes	PORT OPS/VTS
06	156.300	156.300	Inter-ship Safety	Yes	No	SAFETY
07A	156.350	156.350	Commercial	Yes	Yes	COMMERCIAL
08	156.400	156.400	Commercial (inter-ship only)	Yes	No	COMMERCIAL
09	156.450	156.450	Recreational Calling Channel	Yes	Yes	CALLING
10	156.500	156.500	Commercial	Yes	Yes	COMMERCIAL
11	156.550	156.550	Commercial, VTS in Selected Areas	Yes	Yes	VTS
12	156.600	156.600	Port Operations, VTS in Selected Areas	Yes	Yes	PORT OPS/VTS
13 ³	156.650	156.650	Intership Navigation Safety (bridge-to-bridge) 1W with power-up	Yes	No	BRIDGE COM
14	156.700	156.700	Port Operations, VTS in Selected Areas	Yes	Yes	PORT OPS/VTS
15 ¹	156.750	156.750	Commercial – 1W Only	Yes	Yes	COMMERCIAL
16	156.800	156.800	International Distress, Safety, and Calling	Yes	Yes	DISTRESS
17 ¹	156.850	156.850	State Controlled – 1W Only	Yes	Yes	SAR
18A	156.900	156.900	Commercial	Yes	Yes	COMMERCIAL
19A	156.950	156.950	Canadian Coast Guard	Yes	Yes	CANADIAN CG
20 ¹	157.000	161.600	Canadian Coast Guard, Duplex– 1W Only	No	Yes	CANADIAN CG
21	157.050	161.650	Port Operations, Duplex	No	Yes	PORT OPS
21A	157.050	157.050	U.S. Government, Canadian Coast Guard	Yes	Yes	UNAUTHORIZED
21B	RX Only	161.650	Port Operations, RX Only	-----	-----	PORT OPS
22A	157.100	157.100	Canadian Coast Guard Liaison	Yes	Yes	CANADIAN CG
23	157.150	161.750	Public Correspondence, Duplex	No	Yes	TELEPHONE
24	157.200	161.800	Public Correspondence, Duplex	No	Yes	TELEPHONE
25	157.250	161.850	Public Correspondence, Duplex	No	Yes	TELEPHONE
25B	RX Only	161.850	Public Correspondence, RX Only	-----	-----	TELEPHONE
26	157.300	161.900	Public Correspondence, Duplex	No	Yes	TELEPHONE
27	157.350	161.950	Public Correspondence, Duplex	No	Yes	TELEPHONE
28	157.400	162.000	Public Correspondence, Duplex	No	Yes	TELEPHONE

CH	SEND (MHz)	RECEIVE (MHz)	TRAFFIC TYPE	SHIP TO SHIP	SHIP TO SHORE	NAME TAG
28B	RX Only	162.000	Public Correspondence, RX Only	-----	-----	TELEPHONE
60	156.025	160.625	Public Correspondence, Duplex	No	Yes	TELEPHONE
61A ⁴	156.075	156.075	<i>U.S. Government, Canadian Coast Guard</i>	Yes	Yes	<i>UNAUTHORIZED</i>
62A	156.125	156.125	Canadian Coast Guard	Yes	Yes	CANADIAN CG
64	156.225	160.825	Public Correspondence, Duplex	No	Yes	TELEPHONE
64A ⁴	156.225	156.225	<i>U.S. Government, Canadian Commercial Fishing</i>	Yes	Yes	<i>UNAUTHORIZED</i>
65A	156.275	156.275	Port Operations	Yes	Yes	PORT OPS
66A ¹	156.325	156.325	Port Operations – 1W Only	Yes	Yes	PORT OPS
67	156.375	156.375	Commercial, SAR	Yes	No	COMMERCIAL
68	156.425	156.425	Boat Operations, Recreational	Yes	No	SHIP - SHIP
69	156.475	156.475	Commercial Fishing Only	Yes	Yes	COMMERCIAL
70 ⁶	156.525	156.525	Digital Selective Calling - DSC	-----	-----	DSC
71	156.575	156.575	Boat Operations, Recreational	Yes	Yes	PLEASURE
72	156.625	156.625	Intership	Yes	No	SHIP - SHIP
73	156.675	156.675	Commercial Fishing Only	Yes	Yes	COMMERCIAL
74	156.725	156.725	Commercial Fishing Only	Yes	Yes	COMMERCIAL
77 ¹	156.875	156.875	Port Operations – 1W Only	Yes	Yes	PORT OPS
78A	156.925	156.925	Boat Operations, Recreational	Yes	No	SHIP - SHIP
79A	156.975	156.975	Commercial	Yes	Yes	COMMERCIAL
80A	157.025	157.025	Commercial	Yes	Yes	COMMERCIAL
81A ⁴	157.075	157.075	<i>U.S. Government Operations</i>	Yes	Yes	<i>UNAUTHORIZED</i>
82A ⁴	157.125	157.125	<i>U.S. Government, Canadian Coast Guard</i>	Yes	Yes	<i>UNAUTHORIZED</i>
83	157.175	161.775	Canadian Coast Guard	Yes	Yes	CANADIAN CG
83A ⁴	157.175	157.175	<i>U.S. Government, Canadian Coast Guard</i>	Yes	Yes	<i>UNAUTHORIZED</i>
83B	RX Only	161.775	Canadian Coast Guard, RX Only	-----	-----	CANADIAN CG
84	157.225	161.825	Public Correspondence, Marine Operator	No	Yes	TELEPHONE
85	157.275	161.875	Public Correspondence, Marine Operator	No	Yes	TELEPHONE
86	157.325	161.925	Public Correspondence, Marine Operator	No	Yes	TELEPHONE
87	157.375	161.975	Public Correspondence, Marine Operator	No	Yes	TELEPHONE
88	157.425	162.025	Public Correspondence, Marine Operator	No	Yes	TELEPHONE

WEATHER		MHz	TRAFFIC TYPE			NAME TAG
Wx01	RX Only	162.550	NOAA WEATHER CHANNEL	-----	-----	NOAA WX
Wx02	RX Only	162.400	NOAA WEATHER CHANNEL	-----	-----	NOAA WX
Wx03	RX Only	162.475	NOAA WEATHER CHANNEL	-----	-----	NOAA WX
Wx04	RX Only	162.425	NOAA WEATHER CHANNEL	-----	-----	NOAA WX
Wx05	RX Only	162.450	NOAA WEATHER CHANNEL	-----	-----	NOAA WX
Wx06	RX Only	162.500	NOAA WEATHER CHANNEL	-----	-----	NOAA WX
Wx07	RX Only	162.525	NOAA WEATHER CHANNEL	-----	-----	NOAA WX
Wx08	RX Only	161.650	CANADIAN WEATHER CHANNEL	-----	-----	CANADA WX
Wx09	RX Only	161.775	CANADIAN WEATHER CHANNEL	-----	-----	CANADA WX
Wx10	RX Only	163.275	NOAA WEATHER CHANNEL	-----	-----	NOAA WX

SPECIAL NOTES ON CANADA CHANNEL USAGE

1. LOW POWER (1 W) only.
2. Receive Only.
3. LOW POWER (1 W) initially. Override to HIGH POWER by holding down H/L key before transmitting. Used normally in bridge-to-bridge communications.
4. Lightly Shaded Simplex channels 21A, 23A, 61A, 64A, 81A, 82A, and 83A cannot be lawfully used in Canada waters unless special authorization is obtained from the Canadian Coast Guard. Not for use by the general public.
5. The letter "A" illuminated by the channel number indicates the Canada channel is simplex. This same channel is always duplex when selecting International. There is no "A" reference for International channels. The letter "B" is only used for some Canadian "Receive Only" channels.
6. Channel 70 is designated for use exclusively for Digital Selective Calling (DSC), such as Distress, Safety, and Ship Calls. No voice communication is allowed on CH70.
7. The CANADA mode is not legal to use in U.S. waters.

C-4 EU INLAND WATERWAY CHANNELS Country Specific

For specific channel information for your country, please refer to local authorities.

CH	SPECIFIC FOOTNOTES	TRANSMITTING FREQUENCY (MHZ)		SHIP-TO-SHIP	SHIP-TOPORT	NAUT.INFORM
		SHIP	LAND			
60	a)	156.025	160.625			x
1	a)	156.05	160.65			x
61	a)	156.075	160.675			x
2	a)	156.1	160.7			x
62	a)	156.125	160.725			x
3	a)	156.15	160.75			x
63	a)	156.175	160.775			x
4	a)	156.2	160.8			x
64	a)	156.225	160.825			x
5	a)	156.25	160.85			x
65	a)	156.275	160.875			x
6	a) b)	156.3	156.3	x		
66	a)	156.325	160.925			x
7	a)	156.35	160.95			x
67	a) c)	156.375	156.375			x
8	a) q)	156.4	156.4	x		
68	a)	156.425	156.425			x
9	a) b) c)	156.45	156.45			x
69	a)	156.475	156.475			x
10	e)	156.5	156.5	x		
70	a)	156.525	156.525	Digital selective calling for distress, safety and calling		
11		156.55	156.55		x	
71		156.575	156.575		x	
12		156.6	156.6		x	
72	a) r)	156.625	156.625	x		
13	f)	156.65	156.65	x		
73	f) g)	156.675	156.675			x
14	q)	156.7	156.7		x	
74	a)	156.725	156.725		x	
15	h)	156.75	156.75			x
75	o)	156.775	156.775		x	
16	i)	156.8	156.8			x
76	j) d) o)	156.825	156.825			x

17	h)	156.85	156.85			x
77	a) k)	156.875	156.875	x		
18		156.9	161.5			x
78		156.925	161.525			x
19		156.95	161.55			x
79	a)	156.975	161.575			x
20		157	161.6			x
80		157.025	161.625			x
21	a)	157.05	161.65			x
81	a)	157.075	161.675			x
22		157.1	161.7			x
82	l) m)	157.125	161.725			x
23	m)	157.15	161.75			x
83	a) m)	157.175	161.775			x
24	m)	157.2	161.8			x
84	m)	157.225	161.825			x
25	m)	157.25	161.85			x
85	a) m)	157.275	161.875			x
26	m)	157.3	161.9			x
86	a) m)	157.325	161.925			x
27	m)	157.35	161.95			x
87	a) d)	157.375	157.375			x
28	m)	157.4	162			x
88	a) p)	157.425	157.425			x
AIS 1	a) n)	161.975	161.975			
AIS 2	a) n)	162.025	162.025			

1.1 General remarks to frequency table 1

1.1.1 The channels for service categories ship-to-ship and nautical information may also be used for vessel traffic -systems by traffic centres.

1.1.2 In some countries, frequencies certain channels are used for an other service category or other radio services. These countries are Austria, Bulgaria, Croatia, the Federal Republic of Yugoslavia, Hungary, Moldova, Romania, the Russian Federation, the Slovak Republic, the Czech Republic (with exemption of channels 08, 09, 72, 74 and 86), Ukraine and the Federal Republic of Yugoslavia. The Administrations concerned should make any possible attempt to make these frequencies channels as soon as possible available for the radiotelephone service on Inland Waterways and/or the required service category.

1.2 Explanation of specific footnotes in frequency table 1

- a. In the countries mentioned under 1.1.2, it is strictly prohibited to use this channel.
- b. This channel is not allowed to be used between Rhine km 150 and km 350.
- c. In the Netherlands, this channel is used by its on-scene communications during safety operations on the North Sea, IJsselmeer, Waddenzee, Ooster- and Westerschelde.
- d. This channel may also be used for piloting, mooring, tugging and for other nautical purposes.
- e. This channel is the first ship-to-ship channel, unless the competent authority has designated an other channel.
In the countries mentioned under 1.1.2, it is allowed that the output power is set to a value between 6 and 25 W until 1 January 2005.
- f. In the countries mentioned under 1.1.2, this channel is used for service category ship-to-port authorities.
- g. In the Netherlands, this channel is used by its national coastguard for communications during oil pollution operations on the North Sea and for safety messages for the North Sea, Waddenzee, IJsselmeer, Ooster- and Westerschelde.
- h. This channel may be used only for service category on-board on board communications.
- i. This channel may be used only for communications between seagoing vessels and participating land stations in case of distress and safety communications within the maritime sea-areas.
In the countries mentioned under 1.1.2, this channel may be used only for distress, safety and calling.
- j. The output power shall be reduced automatically to a value between 0.5 and 1 W.
- k. This channel may be used for communications with a social character.
- l. In the Netherlands and Belgium, this channel may be used for transmitting messages concerning bunkering and victualling. The output power has to be reduced manually to a value between 0.5 and 1 W.
- m. This channel may also be used for public correspondence.
- n. This channel will be used for an automatic ship identification and surveillance system (AIS) capable of providing worldwide operating on seas and Inland Waterways.
- o. The availability of this channel is on a voluntary basis. All existing equipment shall be capable to of operating on this channel within a ten-year period after the entry into force of this Arrangement.
- p. After permission of the competent authority, this channel may be used only for special events on a temporary basis.
- q. In the Czech Republic this channel is used for service category nautical information.
- r. In the Czech Republic this channel is used for service category ship-to-port authorities.

Special Channels²

CH	SEND (MHz)	RECEIVE (MHz)	TRAFFIC TYPE	SHIP TO SHIP	SHIP TO SHORE	NAME TAG
00 ¹	156.000	156.000	UK Coast Guard Users	Yes	Yes	UK COAST GRD
M1	157.425	157.850	UK Marina Channel M1	Yes	Yes	UK MARINA
M2	161.425	161.425	UK Marina Channel M2	Yes	Yes	UK MARINA
31	157.550	162.150	INT'L, Duplex (Holland)	No	Yes	NL MARINA
96H	162.425	162.425	INT'L (Belgium)	No	Yes	BEL G MARINA
L1	155.500	155.500	INT'L (Skandinavia)	Yes	No	LEISURE 1
L2	155.525	155.525	INT'L (Skandinavia)	Yes	No	LEISURE 2
L3	155.650	155.650	INT'L (Skandinavia– not in Denmark)	Yes	No	LE ISURE3
F1	155.625	155.625	INT'L (Skandinavia)	Yes	No	FISHING 1
F2	155.775	155.775	INT'L (Skandinavia)	Yes	No	FISHING 2
F3	155.825	155.825	INT'L (Skandinavia) call back	Yes	No	FISHING 3
AIS1	161.975	161.975	AIS1	-----	-----	-----
AIS2	162.025	162.025	AIS2	-----	-----	-----

Note:

1. Lightly Shaded Simplex channel CH00 is only available in the UK to Coast Guard users with written authorization.
2. The special channels above maybe fitted to your radio. These are only licensed for use in the country indicated. No attempt should be made to use them in any other country.

Appendix D - MMSID and License Information

You must obtain a user MMSID (Marine Mobile Service Identity) and enter it into your 710 in order to use the DSC functions. Contact the appropriate authorities in your country. If you are unsure who to contact, consult your Northstar dealer.

The user MMSID is a unique nine digit number, similar to a personal telephone number. It is used on marine transceivers that are capable of using DSC (Digital Select Calling).

Depending upon your location, you may need a radio station license for the VHF 710. You may also need an individual operator's license.

Copyright © 2005 Brunswick New Technologies Inc. Northstar™ recommends that you check the requirements of your national radio communications authorities before operating DSC functions.

Section 7 - Installation Section

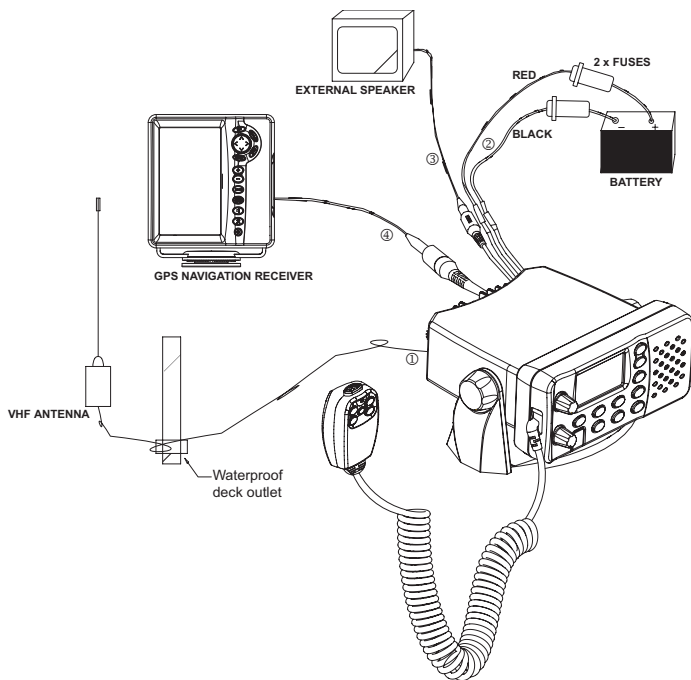

This Northstar radio is designed to generate a digital maritime distress call to facilitate search and rescue. To be effective as a safety device, this radio must be used only within the geographic range of a shore-based VHF marine Channel 70 distress and safety watch system. The geographic range may vary but under normal conditions is approximately 20 nautical miles.

Checklist (pictured over)

The following items should be supplied in the box. Check before starting the installation and contact your dealer if an item is missing. *Note that an antenna is not provided with the VHF Radio. Consult your Northstar dealer for advice if necessary.*

1. Mounting gimbal for the VHF radio
2. Power supply cable and external speaker connection cable
3. Two mounting knobs
4. Microphone bulkhead mount
5. GPS connection cable
6. Four self-tapping screws for the mounting gimbal
7. Four flat screws for the mounting gimbal
8. Four plain washers for the mounting gimbal
9. Four spring washers for the mounting gimbal
10. Four nuts for the mounting gimbal
11. Two self-tapping screws for the microphone bulkhead mount
12. Two flat screws for the microphone bulkhead mount
13. Two plain washers for the microphone bulkhead mount
14. Two spring washers for the microphone bulkhead mount
15. Two nuts for the microphone bulkhead mount.

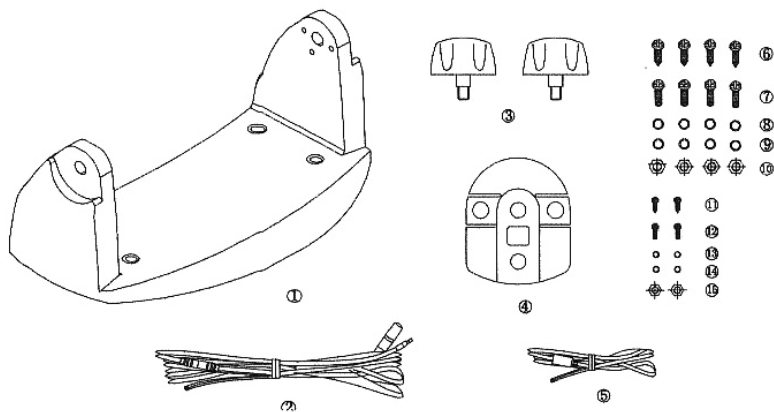

Checklist (middle picture opposite)

16. Two flush mount kit brackets
17. Two M5x32 screws
18. Two M5x10 screws
19. Two lock nuts
20. Two plastic bulkhead bushings.
21. Installation template (not pictured)
22. One 7 Amp spare fuse (not pictured) in case of accidental reverse of the battery polarity

Installation Options

There are two ways to install the radio. You can choose:

- a deck or overhead mounted gimbal installation. The reversible mounting gimbal is fixed to a suitable site and the radio is placed into it. The radio can be removed for storage and the viewing angle can be adjusted.
- a recessed installation. The radio is recessed into a cavity cut into a bulkhead. The radio fixture is permanent and the viewing angle cannot be adjusted.

Location Requirements - Please check these before doing any cutting or drilling.

Whichever installation method you choose, ensure that the chosen location:

- is at least one metre (3') from the antenna
- allows easy connection to (at least) a 10 Amp fused 13.6V DC electrical source and the antenna
- is at least 45cms (1.5') from the compass to avoid creating magnetic deviation of the compass during radio operation
- has a suitable space close by for installing the microphone bulkhead mount
- provides easy access to the front panel controls
- provides reasonable access to the wiring at the back of the radio
- provides enough room to fix the DSC warning label (710US and 720US).

Gimbal Installation

1. Hold the mounting gimbal at the chosen location and use a soft pencil to mark the screw hole positions onto the mounting surface.
2. If you cannot reach behind the mounting surface to attach the nuts, use the 5mm self-tapping screws instead of the flat screws shown in the picture. If you are drilling into fiberglass, use a drill bit smaller than 5mm to drill the pilot holes.
Otherwise, drill the four screw holes where marked, using a 5mm (3/16") drill bit. Drill completely through the mounting surface.
3. Use a Philips screwdriver and the set of four flat screws, spring washers, plain washers, and nuts to attach the mounting gimbal to the location site.
4. Slide the radio into the mounting gimbal.
5. Insert the two mounting knobs through the holes and tighten them sufficiently to hold the radio at the desired viewing angle.

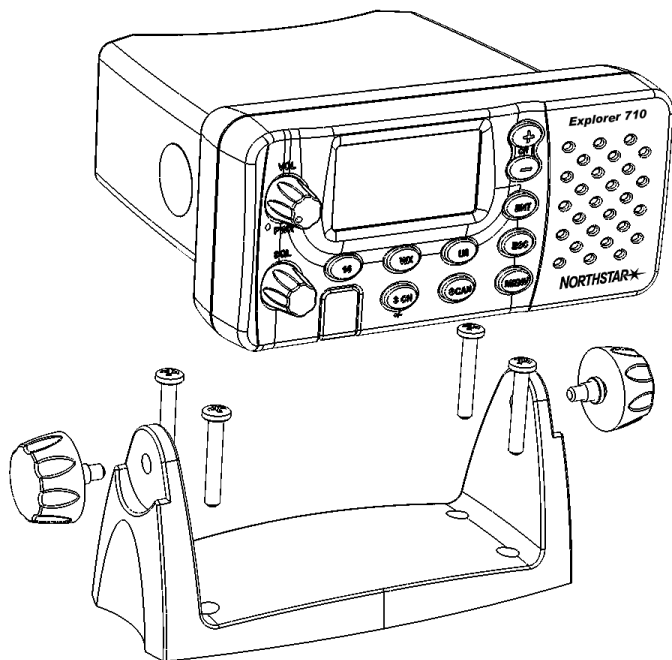

Changing the Viewing Angle

The viewing angle has a 20° tilt range. To change the current viewing angle on a gimbal mount:

1. Support the radio then loosen the mounting knobs until the radio can be moved.
2. Re-position the radio then tighten the mounting knobs again.

Recessed Installation (picture below)

1. Tape the installation template onto the chosen location site.
2. Cut out the area marked by the solid dark line. (The dashed line indicates the total area that will be covered by the radio fascia after installation.)
3. Remove the installation template and slide the radio into the cavity.
4. Working from the rear of the bulkhead, align the ratched outstand on each side of the radio with the central hole in each mounting bracket.
5. Use the two short M5x10 screws to screw the mounting brackets to the sides of the radio.
6. Slide each M5x32 screw through the screw hole in the mounting bracket, then attach the lock nut and the stopper. If your bulkhead exceeds 13mm, the stopper nut can be discarded if necessary.
7. Tighten the M5x32 screws until the radio is held against the rear of the bulkhead.
8. Tighten up the lock nuts to secure the installation.

Connecting the Radio

There are three sockets at the rear of the radio, as shown. The combined power & speaker socket and the GPS socket have short connectors already in place but further electrical wiring is required at the rear of the radio.

Connect the Radio Cables - Rear view of base unit

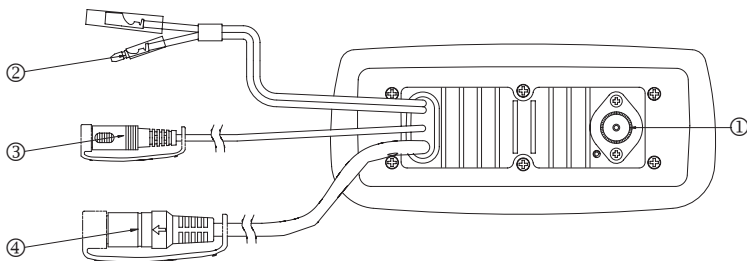

1. VHF Antenna connection. (Antenna is not supplied.)
2. Combined power and speaker cable. The end of the power cable splits in two:
BLACK. Earth. Connect to the (-) NEGATIVE battery terminal.
RED. Power. Connect to the (+) POSITIVE battery terminal. Check that a 10A fuse is installed on this power cable, close to the battery.
3. External speaker cable.
4. GPS connector cable.

Wiring Details

In case a cable is cut accidentally the pinouts are shown here for information only.
Do not cut cables intentionally.

	Cable	Pinout	Color
1	VHF Antenna		
2	Power	1. 13.6V DC +	Red (thick cable)
		2. 13.6V DC -	Black (thick cable)
3	External speaker	1. EXTERNAL SPK +	White (thin cable)
		2. EXTERNAL SPK -	Black (thin cable)
4	GPS connector (pins used)	4. NMEA IN +	Yellow
		5. NMEA IN -	Green
		2. NMEA OUT +	Orange
		6. NMEA OUT -	Black

User MMSID

You must obtain a user MMSID (Marine Mobile Service Identity) and enter it into your 710 or 720 in order to use the DSC functions. Contact the appropriate authorities in your country. If you are unsure who to contact, consult your Northstar dealer. The user MMSID is a unique nine digit number, similar to a personal telephone number. It is used on marine transceivers that are capable of using DSC (Digital Select Calling).

You cannot make any DSC transmissions until you have obtained an MMSID and entered it into your 710 or 720.

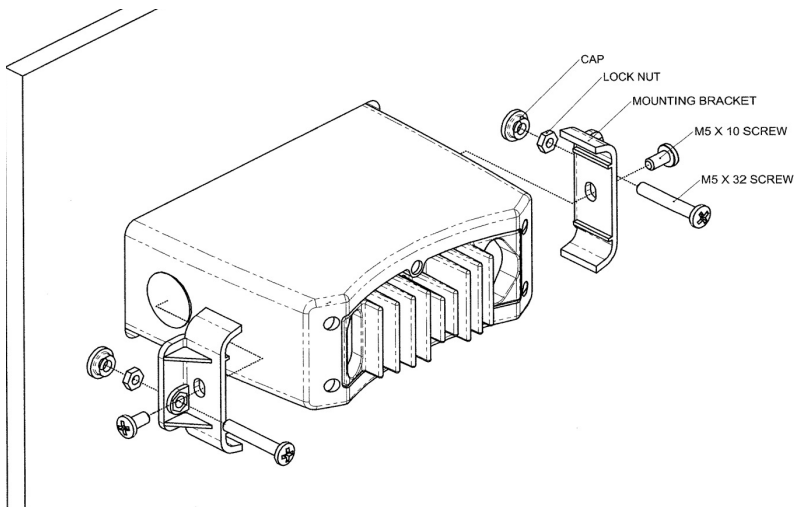

Entering your user MMSID is ONCE ONLY operation.

1. Press and hold CALL/MENU to display the menu.
2. Press +CH- or rotate the knob to select DSC SETUP, then press ENT.
3. Press ENT to select USER MMSID. A dashed line appears.
4. Enter your user MMSID along the dashed line. Use an alphanumeric microphone or the +CH- key. Press ENT to confirm each correct entry.

If you make an error, press - until < is displayed, then press ENT to backup and correct the entry.

5. When your MMSID number is entered correctly, press ENT to store it.
 6. You must re-enter your MMSID again as a password check, then press ENT to store it permanently.
- You can view your stored MMSID anytime in the DSC SETUP screen.

AMERICAS

30 Sudbury Road,
Acton, MA 01720, USA
Ph: +1 978.897.6600
Ph: +1 800.628.4487
Fax: +1 978.897.7241
sales@bntmarine.com

EUROPE

Unit 2, Ocean Quay,
Belvidere Rd, Southampton,
SO14 5QY, ENGLAND
Ph: +44 2380 339922
Fax: +44 2380 330345
northstaruk@northstarnav.com

AUSTRALIA

PO Box 479,
Gladesville, NSW 2111,
AUSTRALIA
Ph: +61 2 9879 9060
Fax: +61 2 9879 9009
northstaraus@northstarnav.com

NEW ZEALAND

PO Box 68 155,
Newton, Auckland
Auckland, NEW ZEALAND
Ph: +64 9 481 0509
Fax: +64 9 481 0590
northstarnz@northstarnav.com

www.northstarnav.com

NORTHSTAR 

FC  CE 0560 